

Product Overview **Besta'Power** Compressed Air and Electric Supply



CONDUCTIX
wampfler
DELACHAUX GROUP





Solutions from a single source!

Solutions are born as ideas and implemented through **products**.

Conductix-Wampfler's handling systems can be found in many industries. Our compressed air and electric supply systems provide solutions to build ergonomic workplaces.

Conductix-Wampfler develops customized system solutions to meet your requirements. Customers from many industries trust Conductix-Wampfler products.

Robust, high-quality products make on-site installation simple. Low maintenance and repair costs save time and money over the system's lifetime.

As a system supplier, we offer our customers complete service, not just the delivery of the products themselves – including steelwork and the lighting if desired. Competent consulting, planning of the entire project, selection and procurement of components and accessories, appropriate logistics design, and on-site commissioning make Conductix-Wampfler stand out.

The result is that critical data and required power are safely, reliably, and permanently available wherever and whenever they are needed.

Anywhere in the world!

You can count on it!



Easy packaging:
C40 with Festoon System
in a shipping warehouse



Fully integrated:
A62 on an assembly line

System Structure

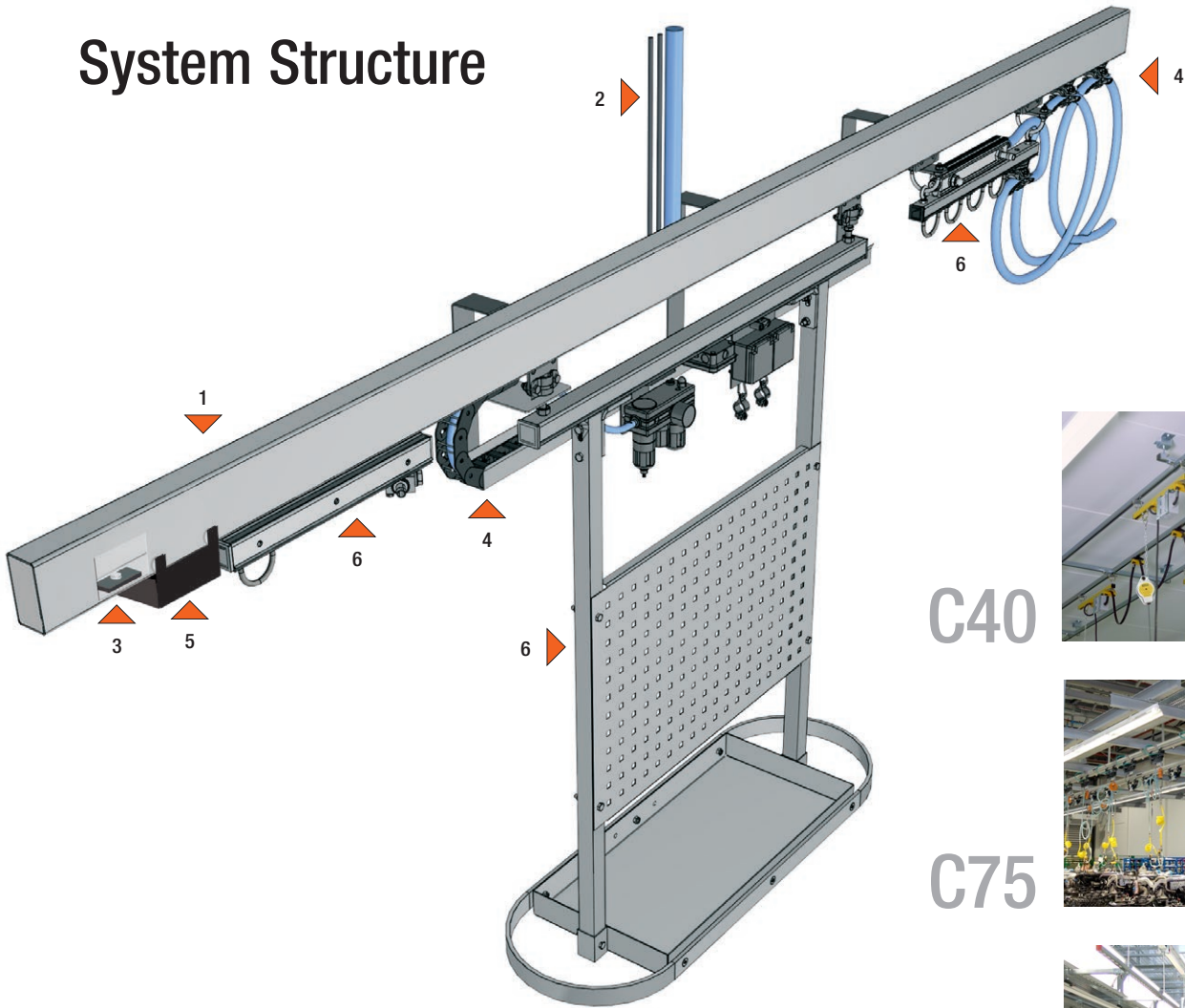

C40

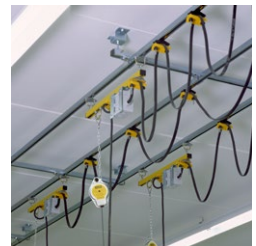

C75

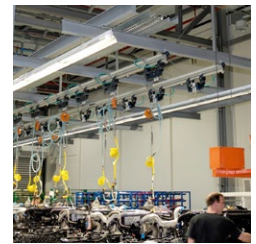

A62



- 1. Track
- 2. Power feed (electrical power, compressed air, etc.)
- 3. Tapping valve
- 4. Mobile power supply (electrical power, compressed air, etc.)
- 5. Tapping carriage
- 6. Equipment carrier

W⁵-traxX















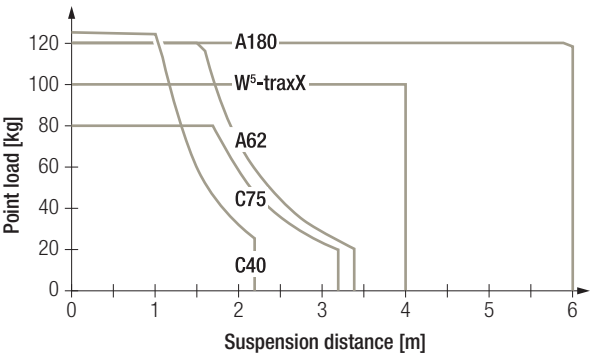













A180



Overview of Program

Bestapower custom media supply: From simple festoon systems to integrated compressed air aluminum profiles with tapping valve.

	C40	C75	A62	W ⁵ -traxX	A180
Page	7	9	11	13	15
Loads and distances					
Max. load capacity [kg] at 2m standard suspension distance					
					
Suspension distance max.	◀ 2.2 m ▶	◀ 3.2 m ▶	◀ 3.4 m ▶	◀ 4 m ▶	◀ 6 m ▶
Integrated compressed air pipe					
Available energy supply					
	Page				
Festoon System	11				
Cable Chain	12				
Tapping Valve System	13				



Series C40

Galvanized Steel C Rail

- **Reliable guiding** provided by robust steel trolleys
- **Simple installation** using variable brackets
- **Compact installation space** due to small cross section



The classical Conductix-Wampfler C rail series is galvanized and available in lengths up to six meters. They can be combined into rail lines of any length.

Energy can be supplied either through a festoon system or by attaching a cable chain.

1:2 Cross Section

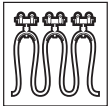
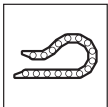
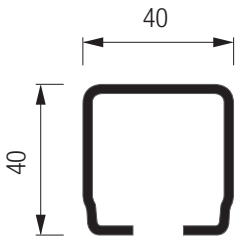

Standard Application Data

Weight	per meter	2.55 kg/m
Profile length		Max. 6 m
Load capacity	Point load	Max. 125 kg*
Suspension distance		Max. 2.2 m
Carriage		Steel carriage, inner runner

Main applications

- Installation workplaces
- Workbenches
- Jib boom equipment
- Equipment crane

* For higher load requirements, please contact factory.



Series C75 Aluminum Profile

- **High stability** provided by optimum cross section aluminum profile
- **Easy and quick installation**
- **Simple carriage after profile installation** without downtime
- **Smooth-running ball bearings** with plastic bandage
- **4 additional grooves** allows quick, easy attachment of accessories
- **Easy to clean** rails and carriages due to externally mounted profile
- **Corrosion-resistant**

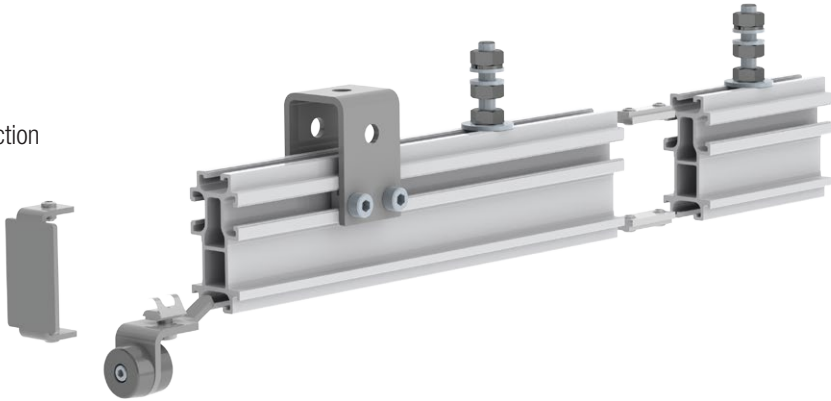

Conductix-Wampfler aluminum profiles are anodized and available in lengths up to six meters. They can be combined into rail lines of any length.

1:2 Cross Section

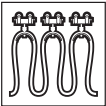
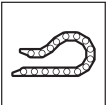
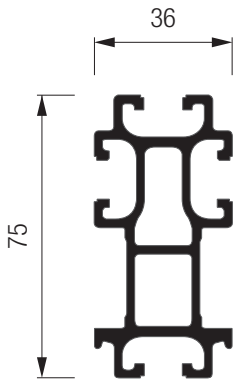

Standard Application Data

Weight	per meter	1.82 kg/m
Profile length		Max. 6 m
Load capacity	Point load	Max. 80 kg
Suspension distance		Max. 3.2 m
Carriage	Steel carriage, ball bearings with plastic bandages, outside running	

Main applications

- Installation workplaces
- Workbenches



Series A62

Aluminum Profile with Integrated Compressed Air Pipe

- **High air flow rate with minimum loss of pressure**, using integrated 2" compressed air pipe
- **Quick, easy installation**
- **Quiet, low-wear movement** with excellent rolling characteristics
- **Additional simple carriage installation** without downtime
- **Complete coverage of work area** with compressed air through integrated outlets
- **Corrosion-resistant**

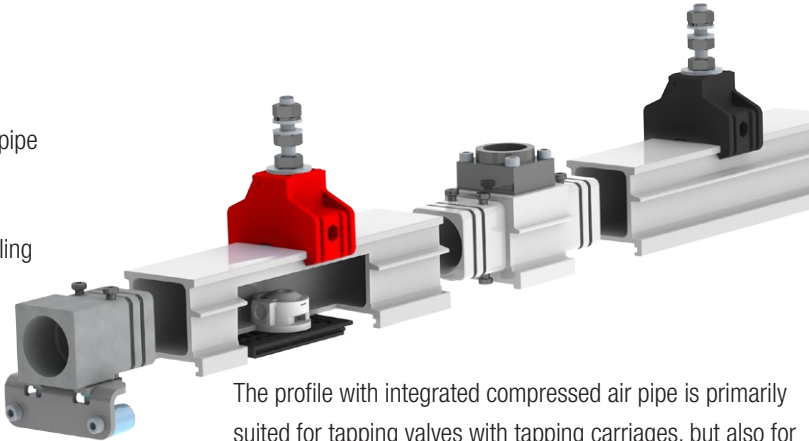

The profile with integrated compressed air pipe is primarily suited for tapping valves with tapping carriages, but also for cable chains. It is therefore available with or without tapping valves. Standard A62 profiles have tapping valves embedded every 1.5 m. The profiles are sealed with silicone-free, oil-resistant O-rings. Maximum sealing and corrosion resistance are guaranteed.

1:2 Cross Section

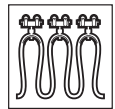
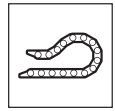
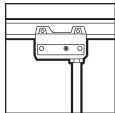
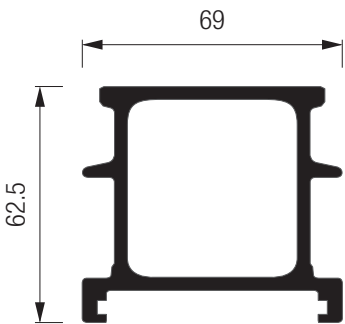

Standard Application Data

Weight	per meter	2.63 kg/m
Profile length		Max. 6 m
Load capacity	Point load	Max. 120 kg
Suspension distance		Max. 3.4 m
Cross section compressed air tank	(~2" pipe)	2098 mm ²
Working pressure		Max. 10 bar
Carriage	Aluminum / plastic with steel rollers, outside running	

Main applications

- Installation workplaces
- Long assembly lines
- Highly automated production lines

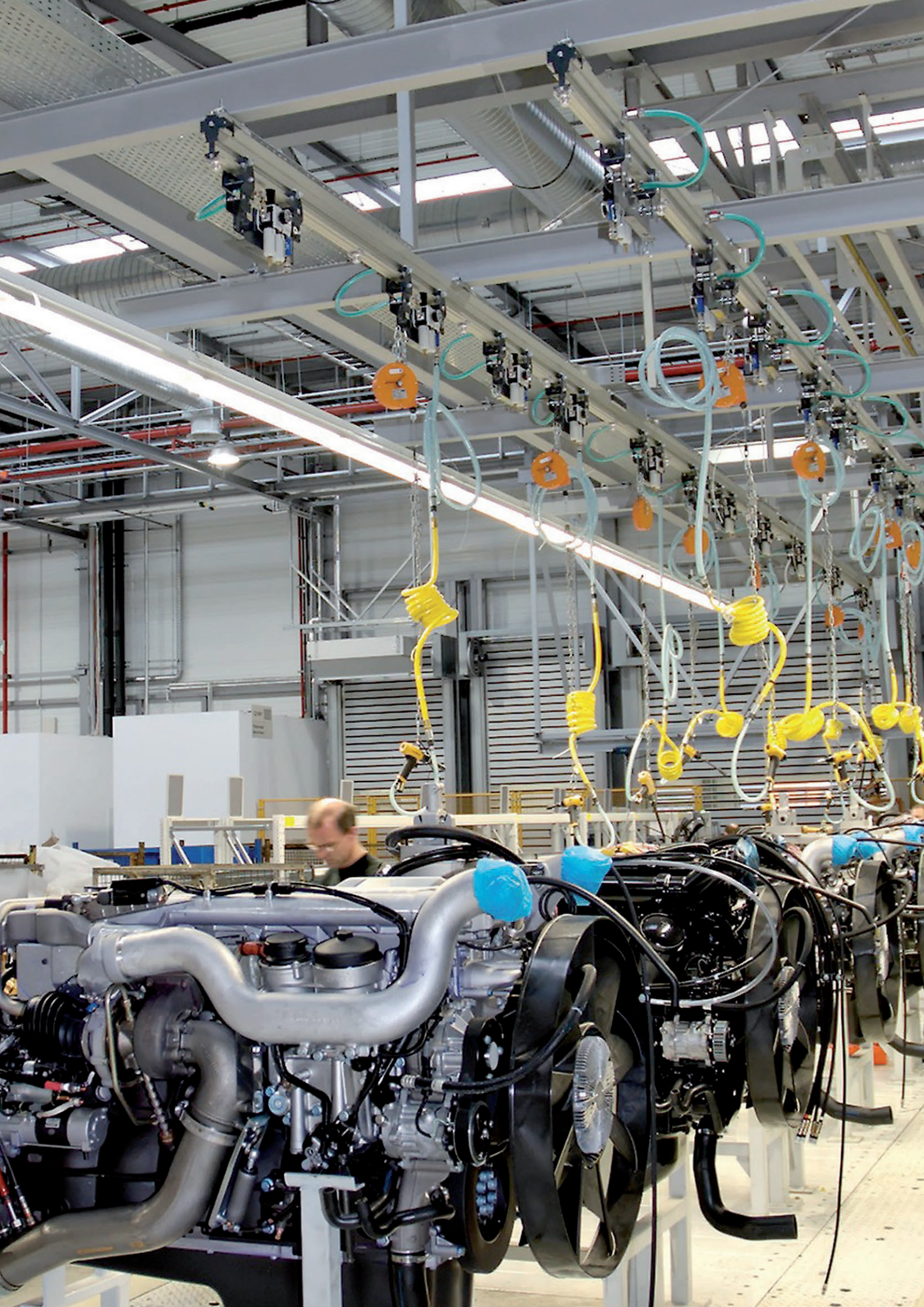

Series W⁵-traxX

Aluminum Profile with Integrated Compressed Air Pipe

- **High load capacity at very low own weight** provided by cross-section-optimized special aluminum profile
- **The optimal compressed air supply, even with many powered devices**, using integrated 2" compressed air pipe
- **Maximum flexibility**, compressed air outlets can be positioned freely
- **Flexible and adaptable**; terminal profiling on all sides
- **Safe, low-friction guiding** due to I-profile trolleys with polyamide flange rollers
- **Corrosion-resistant**

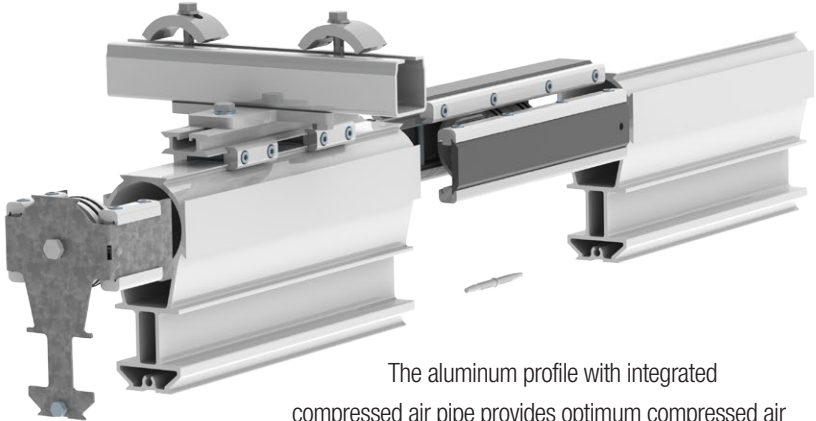

The aluminum profile with integrated compressed air pipe provides optimum compressed air supply even many tools that have high air requirements. The special profile with optimized cross section allows a high load capacity with very low intrinsic weight and its arbitrarily located compressed air outlets permit maximum flexibility. As a standard, we offer profiles with compressed air outlets every 2 m.

1:2 Cross Section

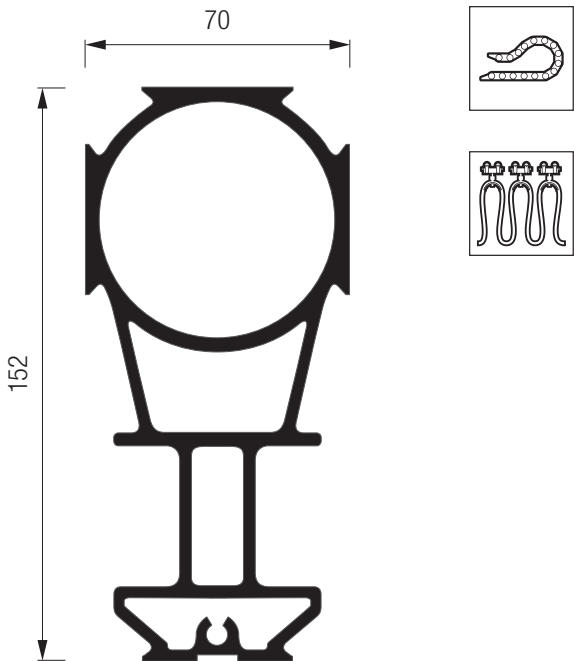

Standard Application Data

Weight	per meter	5.4 kg/m
Profile length		Max. 6 m
Load capacity	Point load	Max. 100 kg
Suspension distance		Max. 4 m
Cross section compressed air pipe	(>2" pipe)	3116 mm ²
Working pressure		Max. 12 bar
Carriage		Steel carriage with polyamide rollers, outside running

Main applications

- Installation workplaces
- Long assembly lines
- Highly automated production lines



Series A180

Aluminum Profile with Integrated Compressed Air Pipe

- Aluminum profile with optimized cross section **permits reduced steel structure** (Optimized with Finite Element Method)
- **Quiet, low-wear movement** with excellent rolling characteristics
- **Simple integration of peripheral devices**, 6 grooves for fastening
- **Additional simple carriage installation** without downtime
- **Corrosion-resistant**
- **Complete coverage of work area with compressed air** through integrated compressed air outlets

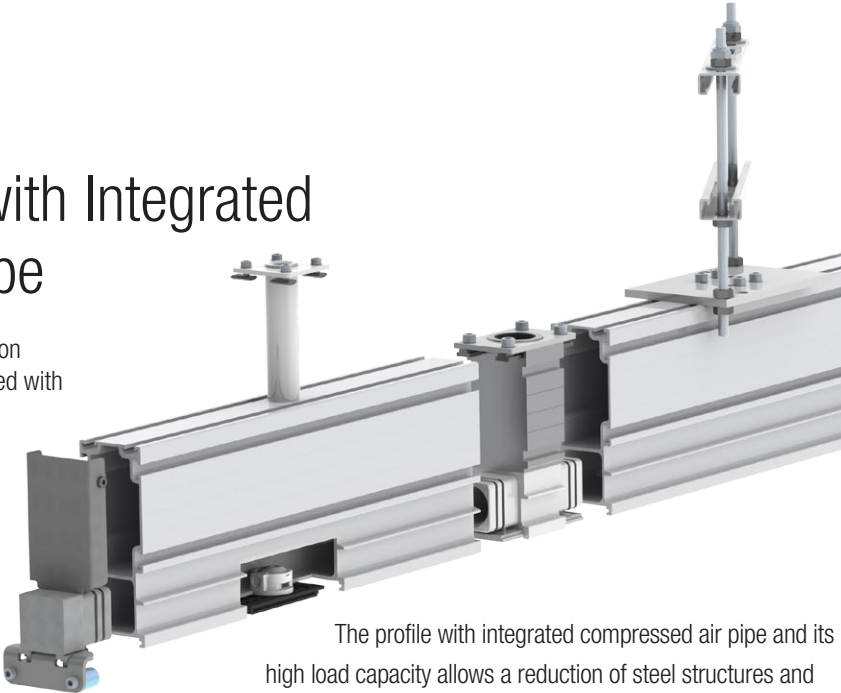

The profile with integrated compressed air pipe and its high load capacity allows a reduction of steel structures and is primarily suited for combination with tapping valves with tapping carriages, but also for cable chains. It is therefore available with or without tapping valves. Standard A62 profiles have tapping valves embedded every 1.5 m. Grooves on three sides permit the attachment of peripherals. The A62 and A180 profiles are compatible.

1:2 Cross section

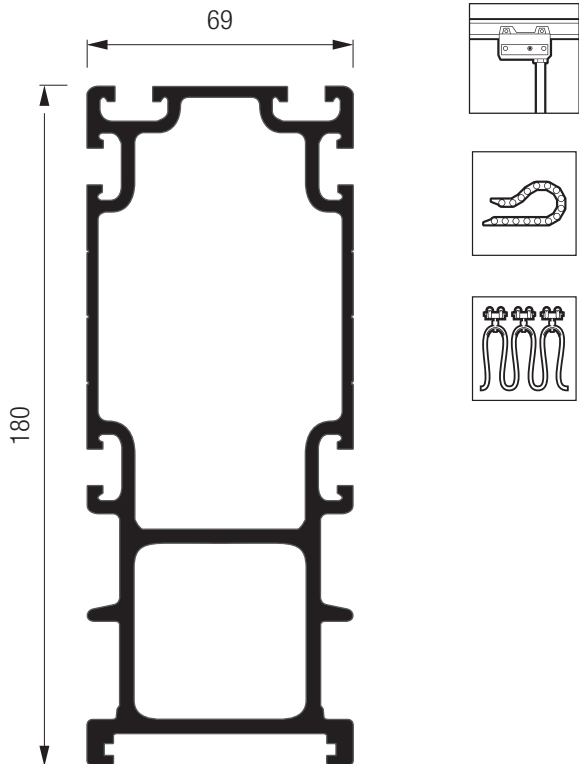

Standard Application Data

Weight	per meter	5.7 kg/m
Profile length		Max. 6 m
Load capacity	Point load	Max. 120 kg
Suspension distance		Max. 6 m
Cross section compressed air pipe	(~2" pipe)	2098 mm ²
Working pressure		Max. 10 bar
Carriage	Aluminum / plastic with steel rollers, outside running	



Main applications

- Assembly workplaces
- Long assembly lines
- Highly automated production lines



Media supply

Three different types of media supply in combination permit the right solution for any customer application case. The matrix below compares their technical characteristics and the associated application possibilities.

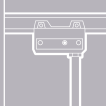
	Festoon System	Cable Chain	Tapping Valve
			
Page	17	18	19
Advantages / characteristics			
No spring force		✓	✓
No line loops		✓	✓
Full utilization of the work area		✓	✓
Continuous compressed air supply	✓	✓	
Electrical power supply possible	✓	✓	✓
Maintenance and disassembly without loss of pressure			✓
No restriction on cycle length			✓
Pressure loss factor *	3	1	2
Installation time factor *	3	2	1

* 1 = very low | 2 = average | 3 = significant

Festoon System

The simplest solution for the supply of compressed air and power, as well as for the use of data cables. Continuous media supply within the work area. Festoon systems can be implemented with any type of profile. With the A62, W⁵, and A180 profiles the compressed air can be taken directly from the rail.

We recommend only limited use of spiral hoses, because they:

- apply spring forces to the user and therefore do not permit ideal ergonomics
- Cause higher pressure loss
- Are costly to purchase and maintain

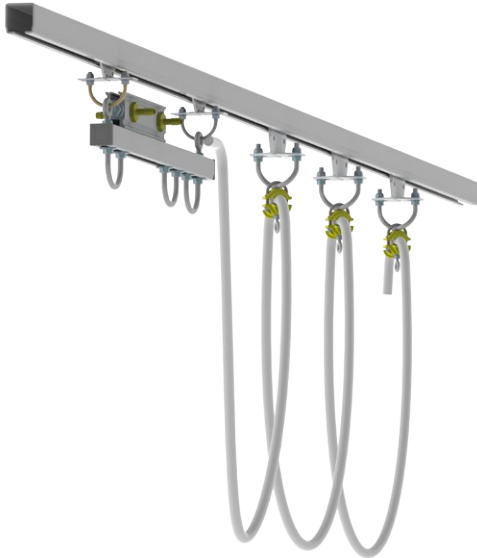

- **Flexible movement** with simple transport system
- **Gentle guiding of hoses and lines** using flexible, multi-level, hanging line holders
- **Simple maintenance and upgrades**

Standard Application Data

System length	Compressed air	Max. 25 m
	Electrical	Max. 25 m
Capacity	Compressed air	Up to 3 hoses 1/2"
	Cables	Up to 10 x round/flat cable
Working pressure	Max. 12 bar	
Interface	Supply using preassembled interface and couplings	
Operating conditions	Interior use; +10°C to 60°C	



Cable Chain

Ideal solution for the continuous supply of compressed air and power as well as the use of data lines, for example for the collection of data about screw connections.

In contrast with the tapping valve solution, compressed air is continuously supplied.

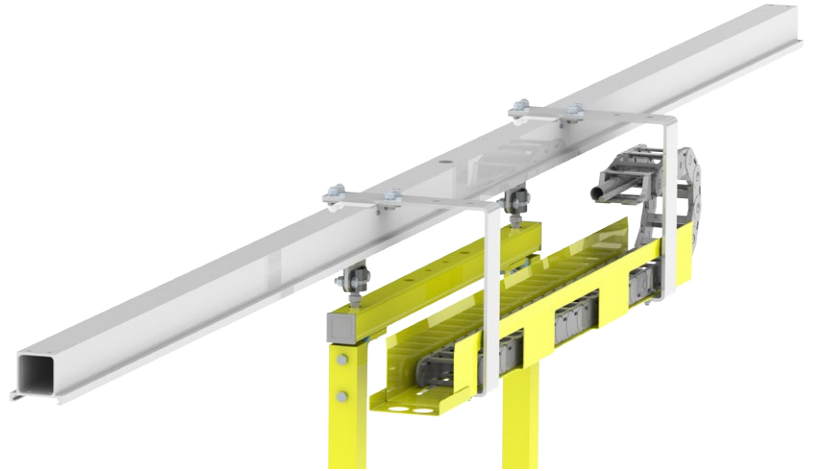

- Suitable for **stationary** and **continuous workstations**
- **Minimal pressure loss** due to center feed
- **No cable loops**
- **Use of complete system length** by eliminating the hose station
- **Minimum force needed to move carrier** with easy-moving rollers

Standard Application Data

System length	Cycle length	18 m
Capacity	Compressed air	2 DN13 hoses
	Power	Up to 4 cables 5 x 2.5 mm ²
Working pressure		Max. 12 bar
Interface	Supply through terminal box/ preassembled interfaces	
Operating conditions	Interior use; +10°C to 60°C	

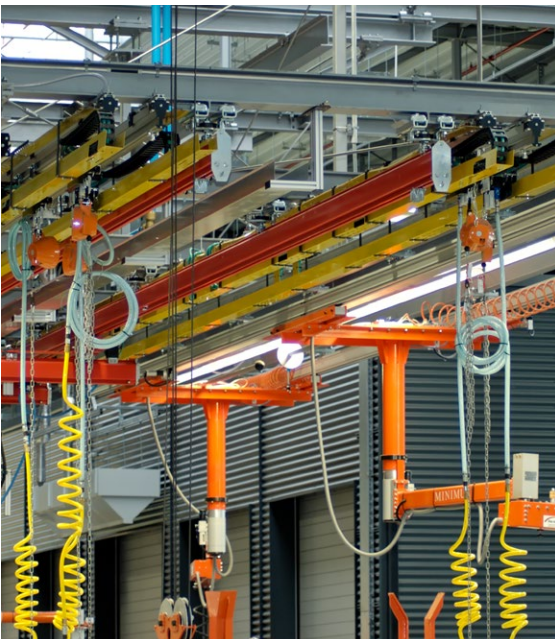

Tapping Valve

By default the A62 and A180 have tapping valves spaced at 1.5m. Other spacing is available as an alternative. The tapping carriages automatically dock when they pass over the tapping valves and supply the tools with compressed air.

The carrier can be disconnected at any time by pulling on the hose or with a detaching device, and moved to the next docking point. Both mechanical and pneumatic detaching devices are available.

The tapping valve allows working along the entire length of the rail profile.

This feature is not available from any other media supply system!

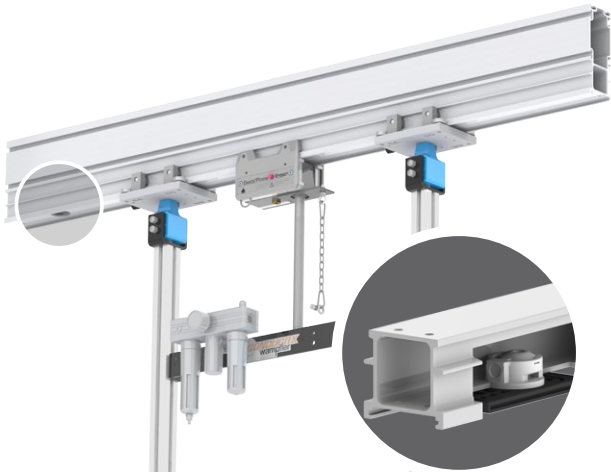

- Suitable for **stationary** and **continuous workstations**
- **High air flow rate** with minimal pressure loss
- **No cable loops**
- **Use of complete system length** by eliminating the hose station
- **Unlimited number of tapping carriages** in a single work cycle
- **Simple addition** of additional workstations
- **Minimum force needed to move carrier** with easy-moving rollers

Standard Application Data

System length	Cycle length	Unlimited
Capacity	Compressed air	Max. 1/2"
Working pressure		Max. 10 bar
Interface	Supply using preassembled interface and couplings	
Operating conditions	Interior use; +10°C to 60°C	





Complete Solutions

Equipment carriers are mobile distribution stations for the energy fed through the media supply system.

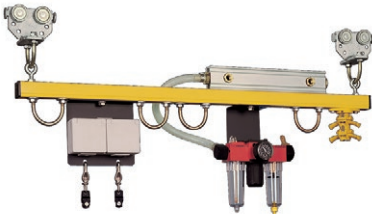

Air treatment
Individual air preparation on-site ensures consistently high performance and a long service life for the tools and devices supplied.

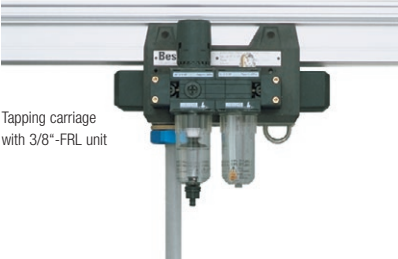

Tapping carriage with 3/8"-FRL unit

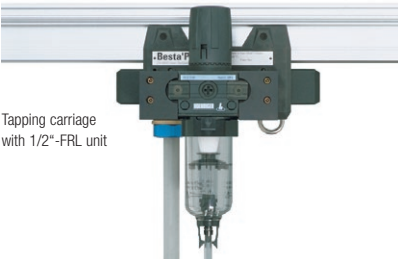

Tapping carriage with 1/2"-FRL unit

Customer-specific solutions are top priority at Conductix-Wampfler. We calculate, plan, and fabricate your entirely custom, ergonomically optimized tool carriers, including all needed accessory elements and equipment.

For individual layout of equipment carriers, Conductix-Wampfler offers a wide variety of **accessories**:

- Compressed air connectors
- Filter regulator-lubricator
- Electrical connections/distributors
- Cable/hose reels
- Balancers/retractors
- Pegboards
- Warehouse storage bins
- Tool Quivers
- Light fixtures
- And many more

Light-weight, but rugged suspension permits significant reduction in steel structure requirements.

Tool transporter
Pull-out lengths of 1750 mm through 3150 mm (optionally adjustable) and rotating variants ($\pm 180^\circ$) allow countless variations in installed equipment.





Custom-fit Service

Industry-specific competence

The scope and depth of Conductix-Wampfler's services are oriented toward the specific requirements of our customers. Services may include: layout and planning, installation and commissioning, and full service contracts. The more complex the system design / operational expectations, the more important it is to make use of our experienced service team. We're ready for your challenge!

Project planning

- Product-neutral consulting
- Selection of the best compressed air and electric supply system optimized for customer requirements, parameters of use, and environmental influences
- Creation of layouts based on customer specifications



Installation and commissioning

- Delivery of preassembled systems
- On-site supervision and inspection available
- Adhering to customer's quality assurance guidelines
- Complete installation and commissioning by trained, experienced technical staff

Service and maintenance

- Regular preventative maintenance and inspections increase the life of your system and ensure many years of use
- Conductix-Wampfler service agreements: the "complete worry-free package"



From project planning and preassembly to on-site installation, Conductix-Wampfler specialists are there for our customers - anywhere in the world!



Your Applications - our Solutions

Compressed Air and Electric Supply from Conductix-Wampfler represent only one of the many solutions made possible by the broad spectrum of Conductix-Wampfler components for the transport of energy, data and fluid media. The solutions we deliver for your applications are based on your specific requirements. In many cases, a combination of several different Conductix-Wampfler systems can prove advantageous. You can count on all of Conductix-Wampfler's Business Units for hands-on engineering support - coupled with the perfect solution to meet your energy management and control needs.



Cable reels

Motorized reels and spring reels by Conductix-Wampfler hold their own wherever energy, data and media have to cover the a wide variety of distances within a short amount of time - in all directions, fast and safe.



Festoon systems

It's hard to imagine Conductix-Wampfler cable trolleys not being used in virtually every industrial application. They're reliable and robust and available in an enormous variety of dimensions and designs.

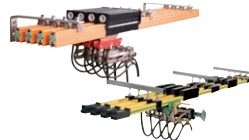

Conductor rails

Whether they're enclosed conductor rails or expandable single-pole systems, the proven conductor rails by Conductix-Wampfler reliably move people and material.

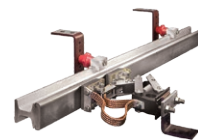

Non-insulated conductor rails

Extremely robust, non-insulated conductor rails with copper heads or stainless steel surfaces provide the ideal basis for rough applications, for example in steel mills or shipyards.

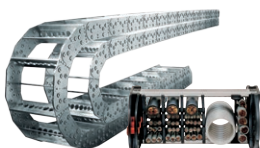

Energy guiding chains

The "jack of all trades" when it comes to transferring energy, data, air and fluid hoses. With their wide range, these energy guiding chains are the ideal solution for many industrial applications.



Slip ring assemblies

Whenever things are really "moving in circles", the proven slip ring assemblies by Conductix-Wampfler ensure the flawless transfer of energy and data. Here, everything revolves around flexibility and reliability!



Inductive Power Transfer IPT®

The no-contact system for transferring energy and data. For all tasks that depend on high speeds and absolute resistance to wear.



Reels, retractors and balancers

Whether for hoses or cables, as classical reels or high-precision positioning aids for tools, our range of reels and spring balancers take the load off your shoulders.



Jib boom

Complete with tool transporters, reels, or an entire media supply system – here, safety and flexibility are key to the completion of difficult tasks.

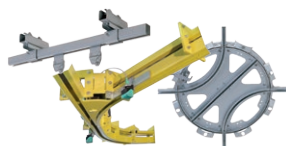

Conveyor systems

Whether manual, semiautomatic or with Power & Free – flexibility is achieved with full customization concerning layout and location.

www.conductix.com

Conductix-Wampfler has just one critical mission: To provide you with energy and data transmission systems that will keep your operations up and running 24/7/365.

To contact your nearest sales office, please refer to:

**[www.conductix.com/
contact-search](http://www.conductix.com/contact-search)**



Ⓞ DELACHAUX GROUP