

ATEX and ICECEX models



Installation and user technical manual (Page.002) **EN**

Operator modules Moka ATEX IECEX:



Operator modules Beta ATEX IECEX:



Operator modules Pika ATEX IECEX:



Operator modules Gama ATEX IECEX:



Transceiver Alto ATEX IECEX
Transceiver Elio ATEX IECEX:



Connection interface unit PYR ATEX IECEX:



Charger PWC and battery PYB and PYB2 ATEX IECEX:



Charger support PWCB02:



Translated from FRA original version (351760H-FR)

TABLE OF CONTENTS

Chapters	Page
1 ---- General safety rules and precautions	7
2 ---- Description and operating principle	9
3 ---- Functional safety	10
3.1---- Emergency stop function	10
3.2---- Safety function stop:	10
3.3---- Life signal:	11
3.4---- Safety function information:	12
4 ---- Operator modules	13
4.1---- General view of operator modules	13
4.1.1-- Gama ATEX operator modules.....	13
4.1.2-- Beta ATEX operator modules.....	14
4.1.3-- Pika ATEX operator modules	15
4.1.4-- Moka ATEX operator modules.....	16
4.2---- Instructions before use	17
4.3---- Using the screen and navigating in the menus	17
4.3.1-- Information displayed by operator module screen	17
4.3.2-- Screen user interface	18
4.4---- Commissioning the operator module.....	19
4.5---- « Association » function (association with a Transceiver)	20
4.5.1-- Searching for Transceiver	21
4.5.2-- Associating a Transceiver to an Operator module.....	22
4.6---- Using the radio control system	23
4.6.1-- Starting up the radio control system	23
4.6.2-- Stopping the operator module	25
4.6.3-- Function selector	26
4.7---- Alert messages.....	27
4.8---- Configuration menu	28
4.8.1-- Accessing the configuration menu.....	28
4.8.2-- Configuration menu summary.....	29
4.8.3-- « Identifiers » menu	30
4.8.3.1 Identity codes	30
4.8.3.2 Serial numbers	30
4.8.3.3 Tables	30
4.8.3.4 Software version of the Operator Module.....	31
4.8.3.5 Hardware.....	31
4.8.4-- « Language » menu.....	32
4.8.5-- « Display » menu.....	33
4.8.5.1 Contrast.....	33
4.8.5.2 Backlighting.....	33
4.8.6-- « Function » menu.....	34
4.8.6.1 Standby	34
4.8.6.2 Dead man.....	35
4.8.6.3 Inclinator.....	35
4.8.7-- « Radio » menu	36
4.8.7.1 Power.....	36
4.8.7.2 Setting the radio channel	37
4.8.7.3 List of available radio frequencies	39
4.8.7.1 Master/Slave	39
4.8.7.2 Pitch&Catch 2.0.....	39
4.8.7.3 Tandem	39
4.8.8-- Test	40
4.8.8.1 Channel scan	40
4.9---- Operator module automatic stop functions	41
4.9.1-- Standby mode	41
4.9.2-- "Deadman"	42
4.10 -- Default configuration of operator module	42
5 ---- ATEX Battery PYB and PYB2 and battery chargers	43
5.1---- Information on battery storage	43
5.2---- Operator module battery: charge level	43
5.3---- General view of charger	44

5.4----	Information on battery charge	45
5.5----	Indicator light on PWC charger and PWCB02● support charger	45
5.6----	Supply of chargers	46
5.6.1--	Power supply by voltage adapter.....	46
5.6.2--	Power supply by external source.....	46
5.7----	Options on PWCB021 charger	47
5.7.1--	Mounting charger bracket PWCB021, PWCB022.....	49
5.7.1.1	Attaching the support charger.....	49
6----	ATEX Transceivers and ATEX Connection interface unit.....	50
6.1----	Explosion-proof housing for Transceivers.....	50
6.2----	Transceiver Alto ATEX : internal view	51
6.2.1--	Wiring terminal strips of Alto ATEX Transceiver	52
6.2.2--	Board with 12 control relay outputs	53
6.2.3--	Board with 12 On/Off inputs + 2 analogue inputs	53
6.2.4--	Board with 6 analogue outputs + 1 BYPASS output.....	53
6.3----	Transceiver Elio ATEX : internal view	54
6.3.1--	Wiring terminal strips of Elio ATEX Transceiver	55
6.4----	Connection interface unit PYR ATEX.....	56
6.4.1--	External view.....	56
6.4.2--	Internal view	57
6.5----	SIM card	58
6.6----	USB connection.....	59
6.7----	Transceiver indicator light functions and messages	60
7----	Options and special functions	61
7.1----	"Master – Master synchronised command" function.....	61
7.1.1--	Operating principle	62
7.1.2--	Use.....	62
7.1.3--	Change to operating mode and system shutdown.....	64
7.1.4--	Procedure for associating Transmitters / Receivers	64
7.1.5--	Procedure to change radio channel.....	65
7.1.6--	Compatibility with "Start up by infrared validation" option.....	66
7.2----	"Tandem synchronised command" function	67
7.2.1--	Operating principle	68
7.2.2--	Use.....	69
7.2.3--	System Shutdown.....	69
7.2.4--	Associating the Transmitter with Receivers.....	69
7.2.5--	Changing the radio channel on a Receiver.....	70
7.3----	« Pitch & catch 2.0» function	71
7.3.1--	Operating principle.....	71
7.3.2--	Use.....	71
7.3.3--	System shutdown (and release)	72
7.3.4--	Configuration.....	72
7.3.5--	Associating an Transmitter with the Receiver.....	72
7.3.6--	Changing the radio channel.....	72
7.3.7--	Replacing an Transmitter (backup model).....	73
7.3.8--	Replacing the Receiver	73
7.4----	"Pick & Control 2.0" function.....	74
7.4.1--	Association in "Pick & Control 2.0"	74
7.4.2--	Operation.....	74
7.4.3--	Stop operation:	76
7.4.4--	Creating and modifying the list	77
7.4.4.1	"Change" menu.....	78
7.4.4.2	"Delete" menu.....	80
7.4.4.3	"Load" menu.....	80
7.4.4.4	"Send" menu.....	81
7.4.5--	Rest channel and operating channel	81
7.4.6--	Transferring a list from transmitter to transmitter.....	82
7.5----	"Frequency agility" automatic channel change function.....	83
7.6----	"Radio power regulation" function.....	84
7.7----	"Deadman" function (detection of operator inactivity)	84
7.7.1--	Manual detection of operator activity.....	84
7.7.2--	Automatic detection of operator inactivity by inclinometer (option).....	84
7.7.3--	Vibrator (option)	84
7.7.4--	Configuration.....	85
7.7.5--	Use.....	85

7.8	---- « Filtering of commands and anti-tapping » option.....	86
7.9	---- « Multimode 3 » and « Multimode 32 » options.....	86
7.10	-- « Inclinometer » function.....	87
	7.10.1 Configuration.....	87
	7.10.2 Use.....	88
8	---- Instructions for installation and commissioning.....	89
8.1	---- Instructions for electrical connection of the Transceiver ATEX.....	89
	8.1.1-- Multi-strand wires: use of wire end ferrules is mandatory.....	90
	8.1.2-- Conductor wire sections to be observed.....	90
	8.1.3-- Alto Transceiver wiring terminals.....	91
	8.1.4-- ATEX Connection interface unit wiring terminals.....	92
	8.1.5-- Interference suppression of the electrical installation and protection of the power supply.....	92
	8.1.6-- Use of an antenna extension.....	92
8.2	---- Transceiver ATEX : Connecting the power supply.....	93
8.3	---- Connection of Ground connectors.....	94
8.4	---- Installation of Connection unit and Transceiver.....	95
	8.4.1-- Cable glands.....	95
	8.4.2-- Procedure for passage of shielded cables through cable glands.....	96
	8.4.3-- Installing the ATEX Transceiver and ATEX Connection interface unit.....	97
	8.4.4-- Mounting the ATEX Transceiver.....	98
	8.4.5-- Mounting the ATEX PYR connection interface unit.....	98
8.5	---- Antennas.....	99
	8.5.1.1 418-419MHz and 433-434MHz Bands.....	99
	8.5.1.2 869MHz band.....	100
	8.5.1.3 911-918MHz band : authorized antennas according to FCC Part 15.204.....	101
	8.5.1.4 2.4GHz band: authorized external antennas.....	102
8.6	---- Wiring diagram: use of safety relays RS1 and RS2.....	103
8.7	---- Instructions for commissioning.....	103
9	---- Maintenance.....	104
9.1	---- Replacement of an operator module or of a Transceiver.....	104
	9.1.1-- Operator modules.....	104
	9.1.2-- Transceiver.....	104
9.2	---- USB connector.....	104
9.3	---- Chargers.....	104
	9.3.1-- Indicator light on support chargers does not come on.....	104
	9.3.2-- Operator module does not charge on its support charger.....	104
10	-- Inspection and servicing.....	105
10.1	-- Inspection and servicing of operator module.....	105
10.2	-- Inspection and servicing of charger.....	105
10.3	-- Inspection and servicing of ATEX Transceiver and ATEX Connection interface unit.....	106
11	-- Technical characteristics.....	107
11.1	-- Definition of markings on ATEX - IECEx products.....	107
11.2	-- ATEX Transmitters.....	109
11.3	-- ATEX Transceivers: Alto and Elio.....	110
	11.3.1 Transceiver Alto ATEX : CONTROL Board.....	111
	11.3.2 Transceiver Alto ATEX : auxiliary boards.....	113
	11.3.3 Receiver ELIO ATEX: CONTROL BOARD.....	114
	11.3.4 Receiver ELIO ATEX: EXTENSION BOARD (option).....	114
11.4	-- Connection interface unit PYR ATEX.....	115
12	-- Warranty.....	116
13	-- FCC Rules & Regulations (Federal Communications Commission).....	117
14	-- IC Regulations (Industry Canada).....	118
15	-- TAIWAN NCC Regulations (National Communications Commission).....	119
	15.1 -- General.....	119
	15.2 -- Regulations.....	119
	15.3 -- Features.....	119
16	-- Safety parameters.....	120
	16.1 -- Parameters calculated according to EN ISO 13849-1 and EN ISO 13849-2.....	120
	16.2 -- Parameters calculated according EN 61508-1-7 and EN 62061.....	123
	16.3 -- « Stop times » characteristics.....	126
17	-- Environmental characteristics.....	127

18--Residual risks	127
19--Forseeable misuse	127
20--Product references.....	127
21--Waste recycling and management.....	127
22--Manufacturer information	127

Reference serial model submitted to approval: August 2020

Congratulations. You have just purchased a JAY Electronique «ATEX – IECEx» remote control system designed for use in an explosible environment.

The various components forming the « ATEX-IECEx » radio control system are designed to meet the safety requirements of the currently applicable and draft standards, and are compliant with the European directives (see section « [UE declaration of conformity](#) »).





The characteristics of the radio remote control satisfy the requirements for use in a "gas" explosible atmosphere zones 0, 1 and 2 depending on products, and in a "dust" explosible atmosphere zones 20, 21 and 22, or "mines" explosible atmosphere depending on products per directive 94/09/CE (see description of Ex marking in section : « [Technical characteristics / Definition of ATEX product marking](#) »

For all questions concerning installation or use of your radio control system, contact our «**Customer Service**» service: Monday to Friday

Tel : + 33 (0)4.76.41.44.00

Email : customer.service@jay-electronique.com

Terms and symbols used in this manual :

Control component	Refers to any control component of the operator module used by the operator to radio control the Transceiver by radio link (such as : single-action pushbuttons, double-action pushbuttons, rotary switches, selectors, joysticks, proportional toggle switches, etc.)
	On Operator Module : Black pushbutton with diamond symbol: « tab » navigation function
	On Operator Module : Black pushbutton with square symbol : « increment » function
	On Operator Module : Green pushbutton with round symbol : « validate » function
	Exclamation point in triangle. This symbol indicates that you must observe the operating and maintenance instructions given in the manual.
	Lightning in triangle. This symbol is used to warn you of a hazardous un-insulated voltage. This voltage can cause a dangerous electrical shock. The symbol indicates that the equipment must not be opened (such as the Transceiver unit) when powered up.

1 General safety rules and precautions

A radio control system is considered as a machine control device and as a safety component used to stop a machine as specified by the EEC Machinery Directive.
All applicable rules must therefore be observed to ensure safe, correct operation of such devices.

The use of the radio control system enables the operator to better focus on his work as it allows him to choose his observation position which is only limited by safety considerations (example: no one should be standing under a load). The radio remote control completes and enhances the classic safety circuits (emergency stop circuits).



- **TO ENSURE SAFE USE, THE INSTRUCTIONS GIVEN IN THIS MANUAL MUST BE STRICTLY OBSERVED.**

- **NEVER OPEN THE ATEX TRANSCEIVER UNIT OR THE ATEX CONNECTION INTERFACE UNIT WHEN AN EXPLOSIVE ATMOSPHERE IS PRESENT.**



- **TO AVOID ANY RISK OF ELECTROCUTION OR EXPLOSION, NEVER OPEN THE ATEX TRANSCEIVER UNIT OR ATEX CONNECTION INTERFACE UNIT WHEN POWERED UP. When accessing the interior of the unit, make sure there is no power in the electrical power supply and control cables.**



- **During any intervention requiring the opening of the ATEX Transceiver housing, you have to take the necessary precautions in order not to degrade the surface state of the 2 jointing planes of the cover seal.**



- **Following any intervention requiring opening of the ATEX Transceiver housing, be sure to apply a layer of silicon grease (supplied with ATEX transceiver) to the jointing plane of the cover seal.**



- **All the ATEX Transceiver cover screws (18 screws) must be securely in place before the unit is switched on.**



- **When installing the ATEX Transceiver housing, make sure that the explosion-proof seal is kept away of at least 30 mm from any solid obstacle (steel frames, PYR ATEX connection interface unit, walls etc ...).**



- **Respect the recommendations of the document : «Safety Notes - ATEX-IECEX Housing» reference : 352430.**



- **To convey electrical power, it is necessary to use shielded cables with suitable cable-glands.**



- **When using cable link, the ATEX Transceiver shall only be connected to intrinsically safe certified equipment. This combination must be compatible as regard intrinsic safety rules (see electrical parameters on the ATEX transceiver marking).**



- **Tighten the cable glands or caps until blocking into the PYR ATEX interface unit housing.**



- **Respect the tightening torque values of cable glands on the cables indicated in the user and installation manual 351760.**



- **The ATEX battery (Ref. **PYB, PYB2**, color-coded blue) or the ATEX operator module Beta 2 must only be charged outside the explosive area.**





- **Housing of the Beta or Moka ATEX operator module must not be opened. The Beta or Moka ATEX operator module can be dismantled only by a trained staff, in a «controlled» environment, spare parts can be changed only by identical and original parts.**





- **Connection interface unit ATEX PYR: Maintain a stripping length of 9 to 11 mm. Ensure that each wire is inserted to the stop into the terminal and no nude active part should be visible.**

-
-  Connection interface unit ATEX PYR: the cable glands and closing elements must be certified for the types of protection Ex e and Ex tb. Drilling diameters = 4x32.5mm and 4x20.5mm.

 -  Connection interface unit ATEX PYR: make sure that the housing is firmly closed before powering up.

 -  The maximum current carrying capacity across the connection terminals must be observed (see section *Technical characteristics / Transceivers Alto Elio and Connection interface unit ATEX PYR*).

 -  The temperatures at the entry points of the wires can be higher than 70 ° C.

 -  Connection interface unit ATEX PYR: cables shall withstand a maximum temperature of conductors higher than 70°C for a maximum current per connection $I_m : 4A$

 -  The intrinsically safe apparatus shall only be connected to associated intrinsically safe apparatus certified for the intended use. This association shall comply with the requirements of the standard EN 60079-25.

 -  USB connection shall not be used in dangerous area

 -  The MOKA equipment must be only powered by a battery ref. PYB2 in explosible area. The other equipments must be only powered by a battery ref. PYB in explosible area.

 -  The battery shall be charged in a safe area with T_{amb} of 0°C to +45°C.

 -  The equipment contains more than 15% aluminium and must be used in such a way as to avoid the risk of sparks from friction or impact.

 -  Only the strap ref : PYM110 shall be used

 -  Only an antenna extension insulated from earth shall be used

 - The operator must be appropriately trained and certified to operate machines by radio control.

 - The operator must have uninterrupted visibility of the manoeuvre which he is performing. When the operator's direct field of view is inadequate, the lifting machinery must be equipped with auxiliary devices to improve visibility.

 - When several machines are being moved simultaneously, the equipment must be fitted out to limit to consequences of a possible collision.

 - Never leave the Beta or Moka ATEX operator module unattended in any haphazard location, even though it is equipped with a "Standby Mode" function which automatically cuts out the system.

 - Never leave the Beta or Moka ATEX operator module to sunlight (eg vehicle windscreens), or near a heat source.

 - If several radio controls are used at the same site, different radio frequencies should be used.

 - In the event of a malfunction, immediately shut down the installation by pressing the stop palmswitch on the ATEX operator module and remove the battery if it is possible.

 - Service your equipment and perform all the periodic checks as may be required by the intensity with which your equipment is used. Follow necessarily the instructions of cleaning described in the chapter «*Inspecting and servicing*».

 - Take all possible precautions so that a malicious intelligence equipped with means of recording and replaying radio exchanges cannot take control of the installation by spoofing the command of the transmitter associated with the receiver.

2 Description and operating principle

A radio control assembly is formed by two components: an **operator module** (for example: « **Moka** » type) and a **transceiver** (for example: « **Alto** » type).

The **operator module** transmits the commands to the **transceiver** which decodes the commands and puts them into action in accordance with its outputs (relay, analogue or BUS outputs).

The radio link between the **operator module** and the **transceiver** is bidirectional ; this allows return of **transceiver** inputs/outputs information used for radio control.

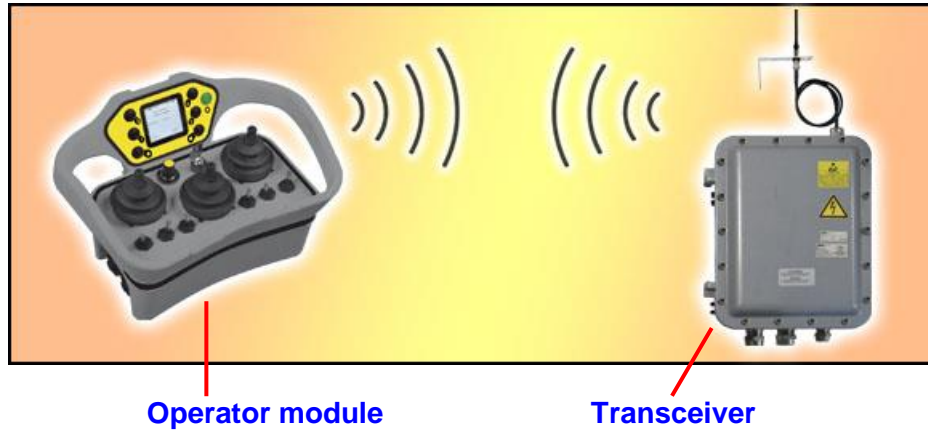

Example :



The **transceiver** contains the configuration of the **operator module** corresponding to the application (also referred to as the « application memory »). A simple association procedure is required to allow the **operator module** to recover the application configuration.

The link between the two elements is ensured through an « **identity code** » (unique, frozen code, stored in the **transceiver**).

The **operator module** is formed by :

- a display screen
- a safety stop palmswitch
- a green pushbutton (for « On » and « Validate » functions) 
- a black « tab » navigation pushbutton 
- a black « increment » pushbutton 
- control components corresponding to the configuration required for the application (such as : single and double-action pushbuttons, rotary switches, selectors, joysticks, etc.)

The **Transceiver** is formed by :

- two safety relays
- an « On » relay
- inputs/outputs corresponding to the configuration required for the application.

3 Functional safety

3.1 Emergency stop function

The **STOP function** leads to go to the safe position of the Wireless Remote-Control System when the operator presses the **Emergency STOP** red mushroom button.

By activating the emergency stop button:

- The remote control will be shut down.
- The state of the safety relay on the receiver will be **OFF**.

The undesired event of the **Emergency Emergency STOP function** is the non-execution of the Emergency STOP function.

The safe state of the **Emergency STOP function** is to open safety relays.

In case of loss of communication or incorrect frame receive, the receiver goes in passive stop time and the state of the safety relays turn to open after a delay defined by iDialog. To know the different timing, please check the chapter "[16.3 « Stop times » characteristics](#)"

The performance level and safety parameters of the **Emergency stop function** are described in the chapter: "[16 Safety parameters](#)"

3.2 Safety function stop:

The **safety function stop** leads to check the neutral position of an actuator to prevent an unwanted action of the machine.

When all the safety actuators are released, the functional safety relay state is **OFF**.

The undesired event of the **Actuator safety function** is sending an unwanted order to the machine while all safety actuators are in neutral position.

The safe state of the **Actuator safety function** is to open the functional safety relay.

The safety relevant actuators are defined by iDialog. To know, how to configure a safety input, please check the iDialog user manual.

The **Actuator safety function** is split in 3 types of safety actuator depending of the operator module:

- **"Dual way" input :**

To send a safety order to the receiver to let him state the functional safety relay to ON. The user must press at least 2 actuators.

The Dual_way inputs are:

- On BETA: F1 to F6, N1, N2, A13.
- On GAMA: N1,N2
- On PIKA/MOKA: F1 to F4, N1, N2, V1, V2, V3, C1_1, C1_2, A13.
-

To be in safe state, all dual-way input defined as safety relevant must be in neutral position (unpressed).

- Activation time: 189 ms
- In case of failure, safe state will occur in: 675 ms + passive stop time.

● **Function button - Safety button / enable switch**

To send a safety order to the receiver to let him state the functional safety relay to ON. The user must press at least 1 actuator.

This function is only available on PIKA/MOKA.

- The safety button/Enabling switch is: A14.

This function is only available on GAMA.

- The function buttons are: F1 to F10.

To be in safe state, all dual way/Function button/Safety button/Joystick defined as safety relevant must be in neutral position (unpressed, or on third position for Enabling Switch).

- Activation time: 189 ms
- In case of failure, safe state will occur in: 675 ms + passive stop time.

● **Joystick**

To send a safety order to the receiver to let him state the functional safety relay to ON. The user must press at activated at least 1 joystick.

This function is only available on PIKA/MOKA.

- The Joysticks are: J1,J2,J3.

To be in safe state, all dual way/Function button/Safety button/Joystick defined as safety relevant must be in neutral position (unpressed/joystick release).

- Activation time: 189 ms
- In case of failure, safe state will occur in: 675 ms + passive stop time.

● **Functional safety relay**

The **functional safety relay** is available on ALTO and NEMO. The functional safety relay must be place in series with the function relays. Please check the chapter 6.1.4.6

The performance level and safety parameters of the actuator safety function are described in the chapter: "15 Safety parameters".

Delays if the functional safety relay is in failure: 378 ms



The functional relay R1, R2 or functional relay on ALTO are not part of the safety function. Only RSF3 and RZ are monitored.

RSF3 and RZ must be placed in order to cut the power supply which go trow the functional relay.

To know how to configure RZ and RSF3, please check the iDialog user manual.

Please make sure to define RZ and RSF3 as safety relay to use the safety function "dual-way" input, safety button or Joystick.

Please, check the parameters of the product before started it. More information inside chapter 5.7.9.1 Procedure in iDialog user manual

3.3 Life signal:

A **Life signal** can be used in Master-Master mode and Tandem mode. The life signal allows to not activate the functional safety-relay if the other MT is in failure or if no radio frame is received from the other MT.

This function must be associated to the actuator safety function to not let a MT move without the other. The life signal can be configured by iDialog.

The performance level and safety parameters of the life signal are described in the chapter: "16 Safety parameters".

- Maximum delays between MT stops: 1189 ms

3.4 Safety function information:

- **Safety function icon**

The safety function is available if at start-up the MO display the following icon:

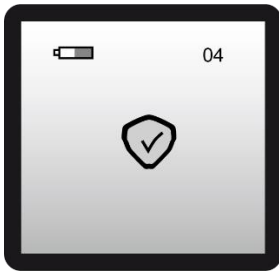

Warning: If the icon is not display at start-up and you have set the safety function please, contact the customer services

- **Safety relevant input:**

The information of which safety input as been set is present inside the menu "configuration -> test -> bouton".

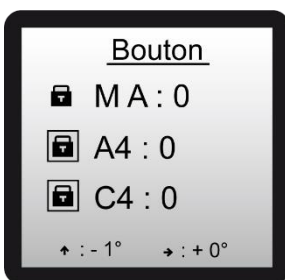

When an input is pressed, if the icon  is display, that mean the input as been configured as safety relevant on an exploitation mode.

The input will block the start-up and the change of exploitation mode if activated.

4 Operator modules

4.1 General view of operator modules

4.1.1 Gama ATEX operator modules

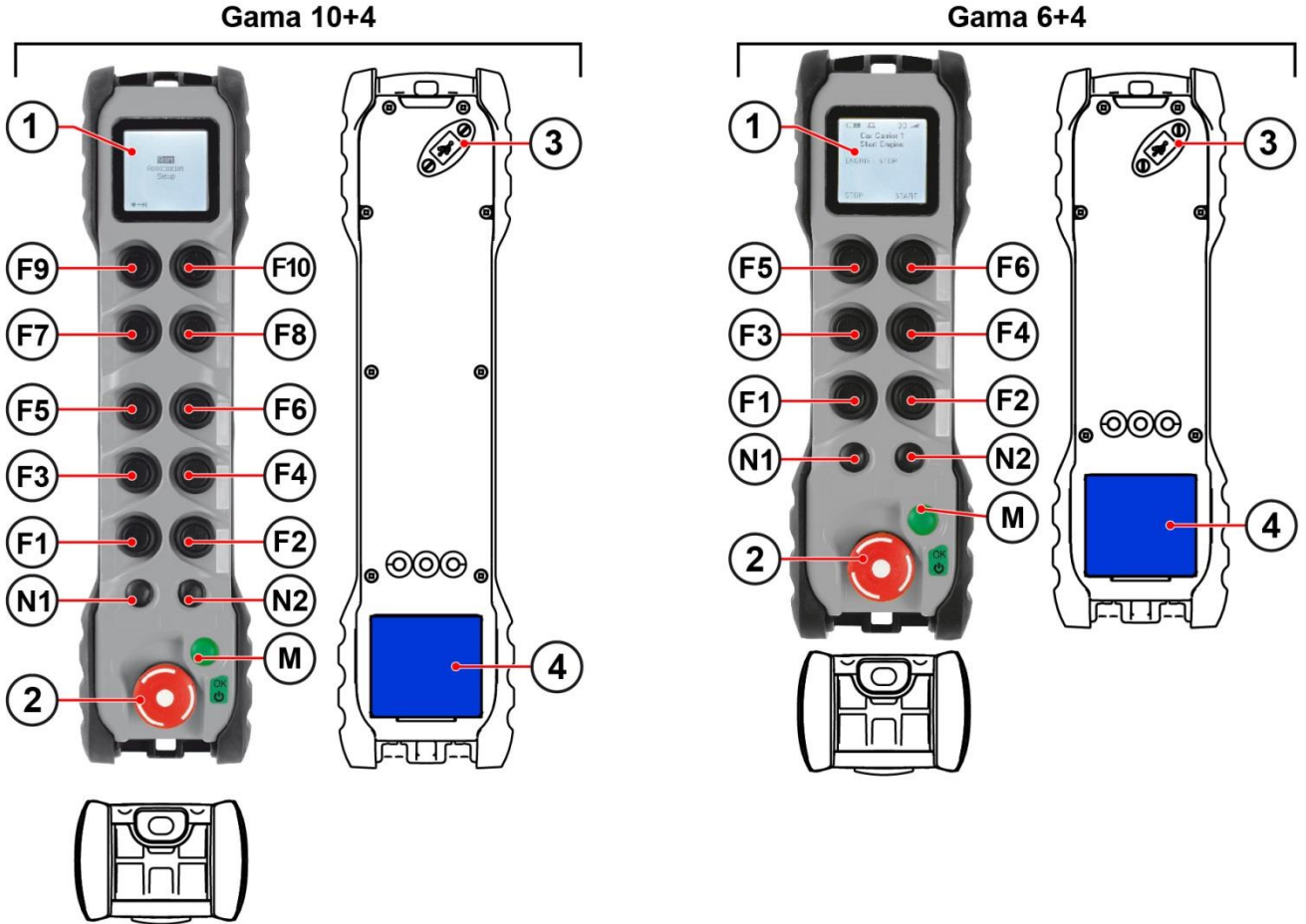

1	Screen
2	Emergency stop palmswitch
3	Access to the USB connection
4	Plug-in battery (blue color)

N1	Browsing pushbutton « Tab »	
N2	Input pushbutton « Increment »	
M	Pushbutton « ON » and « Validation »	

F1 to F10	Function buttons with single or double action
------------------	---

4.1.2 Beta ATEX operator modules

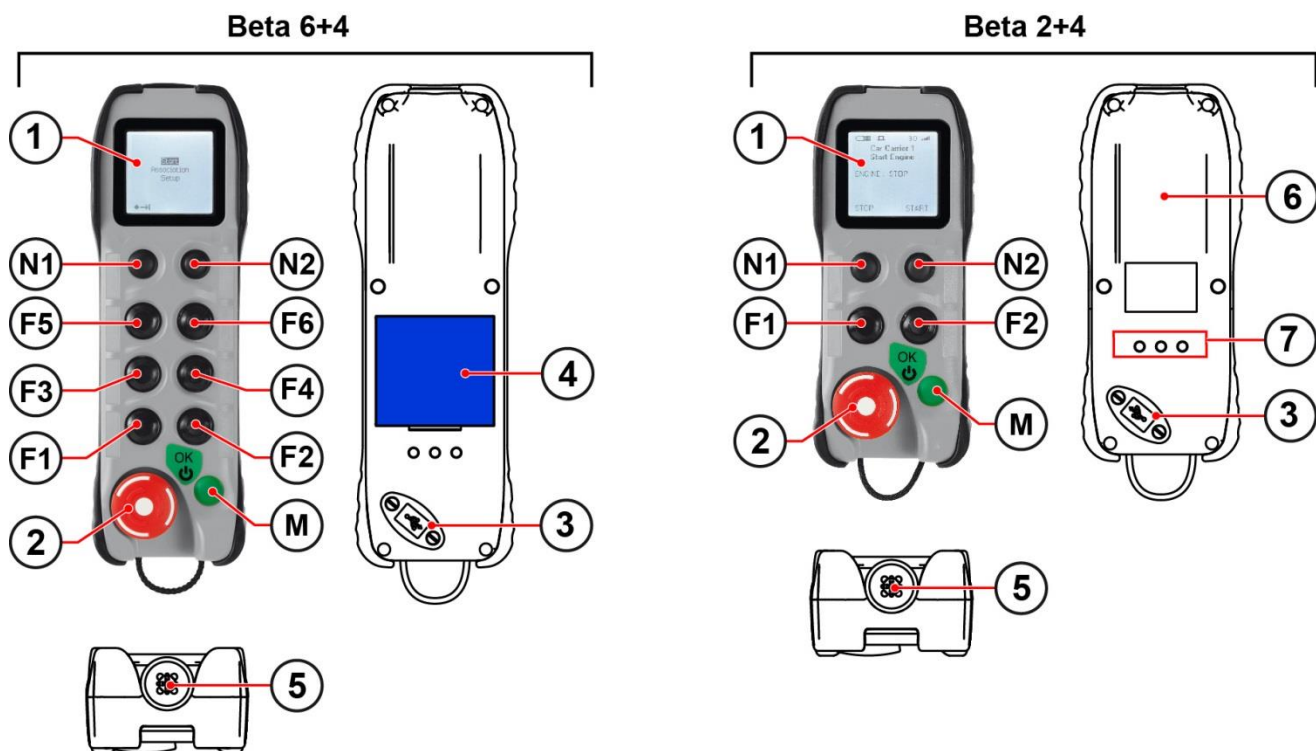

1	Screen
2	Emergency stop palmswitch
3	Access to the USB connection
4	Plug-in battery (blue color)
5	Location for optional element (IR cell, antenna etc. ...)
6	Internal battery
7	Contacts for recharging the internal battery (support charger for Beta 2+4)

F1 to F6	Function buttons with single or double action
-----------------	---

N1	Browsing pushbutton « Tab »	
N2	Input pushbutton « Increment »	
M	Pushbutton « ON » and « Validation »	

4.1.3 Pika ATEX operator modules

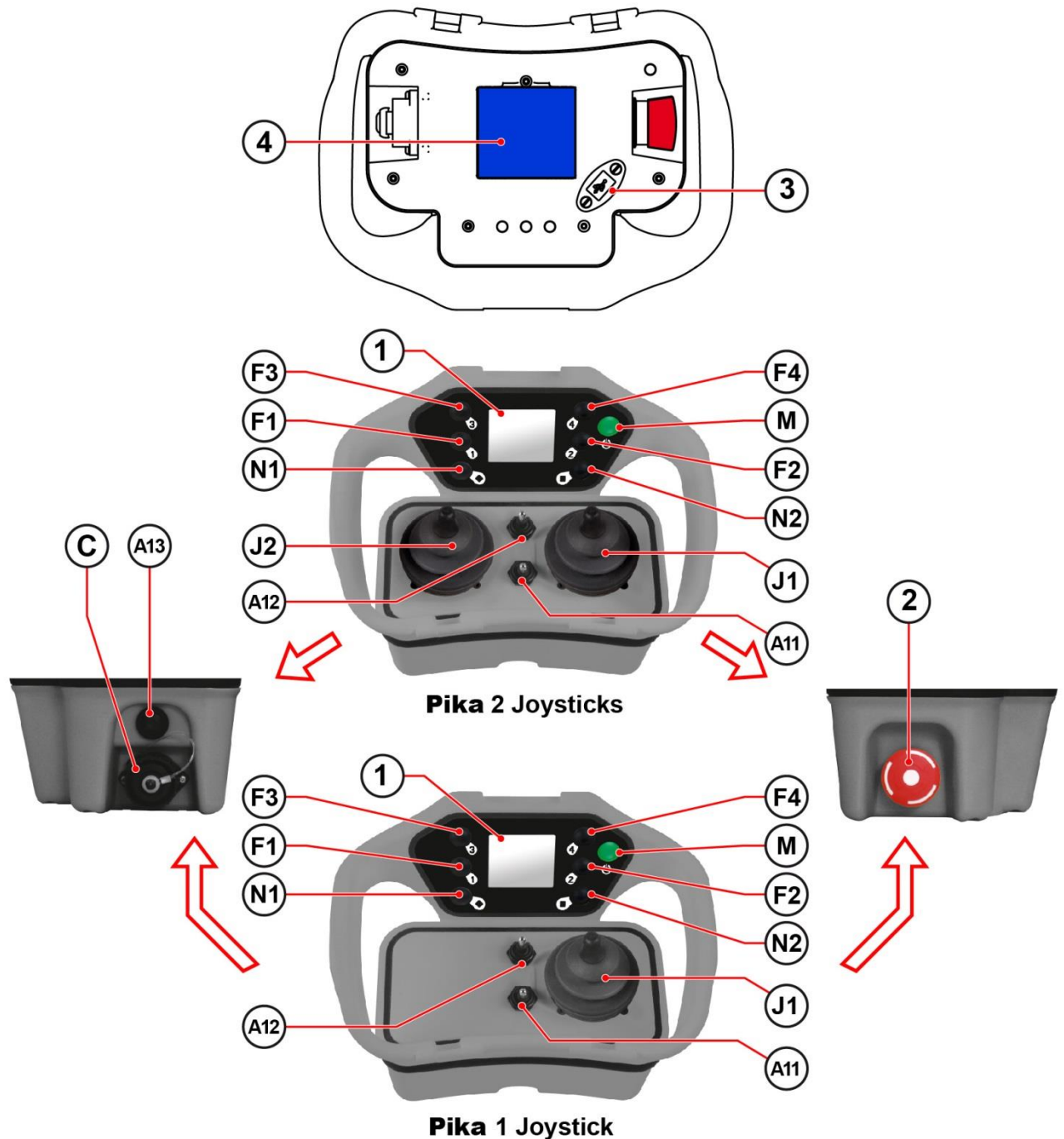

1	Screen
2	Emergency stop palmswitch
3	Access to the USB connection
4	Plug-in battery (blue color)
A13	Location for optional element : Pushbutton
C	Location for optional element : Industrial connector

N1	Browsing pushbutton « Tab »	
N2	Input pushbutton « Increment »	
M	Pushbutton « ON » and « Validation »	

F1 to F4	Function buttons with single action
A11, A12	Auxiliary control devices (selector, push button, rotary switch etc. ...)
J1, J2	Joysticks (optional validation pushbutton)

4.1.4 Moka ATEX operator modules

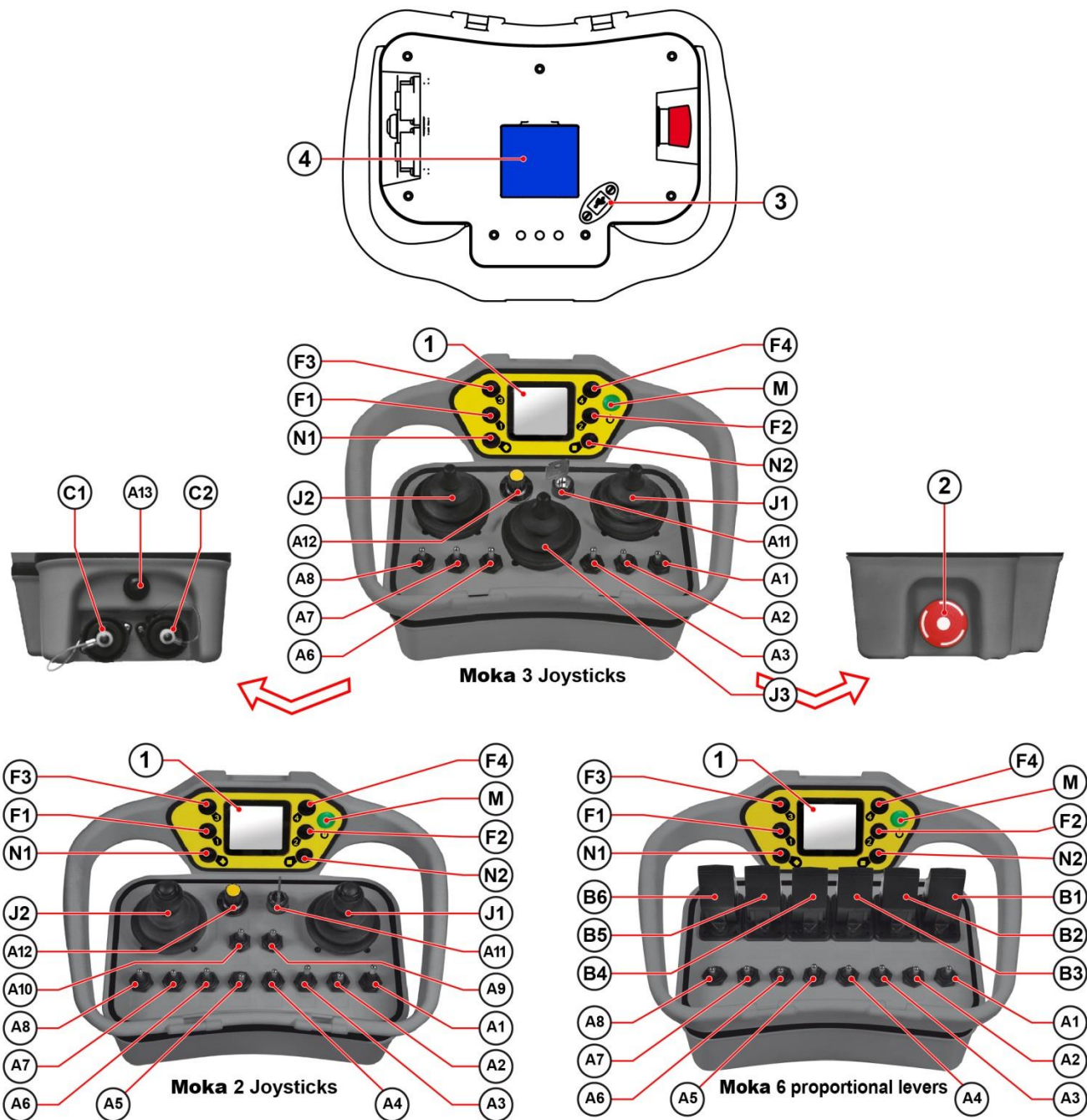

1	Screen
2	Emergency stop palm switch
3	Access to the USB connection
4	Plug-in battery (blue color)
A13	Location for optional element : Pushbutton
C1	Location for optional element : Industrial connector
C2	Location for optional element : Industrial connector

N1	Browsing pushbutton « Tab »	
N2	Input pushbutton « Increment »	
M	Pushbutton « ON » and « Validation »	

F1 to F4	Function buttons with single action
A1 to A12	Auxiliary control devices (selector, push button, rotary switch etc. ...)
J1 to J3	Joysticks (optional validation pushbutton)
B1 to B6	Proportional levers

4.2 Instructions before use

- **On reception of the product**, you must completely charge the battery. To charge the battery, use the battery charger alone or the support charger of the operator module. Refer to the section « **Chargers and Charger supports** » for information concerning use.

⚠ Reminder : The ATEX battery (ref. : PYB,PYB2 color-coded blue) or Beta 2 ATEX operator module must only be charged outside the ATEX area.

- **The installer must** check that the control components of the operator module are properly matched up with the control outputs for the application using the « **Configuration sheet** » supplied with the radio-control system (PDF file on a USB key-card).

4.3 Using the screen and navigating in the menus

4.3.1 Information displayed by operator module screen

The operator module screen is used to display text and pictograms to facilitate use of the equipment.

During use, the screen has 12 display areas :

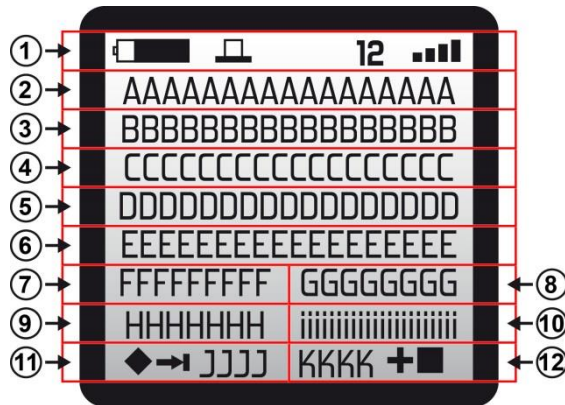

Area	Description
1	Information relative to radio control system status: = « Battery level » pictogram = « Control component position status » pictogram 12 = Radio channel currently being used = Quality of radio link between Operator module and Transceiver
2	Name of radio controlled equipment
3	Name of operating mode (line No. 1)
4	Name of operating mode (line No. 2) or transceiver information No. 1 return
5	Transceiver information No. 1 or No. 2 return
6	Transceiver information No. 2 or No. 3 return
7	Name of function or selection No. 5
8	Name of function or selection No. 6
9	Name of function or selection No. 3
10	Name of function or selection No. 4
11	Name of function or selection No. 1 Display of pictogram when required by menus
12	Name of function or selection No. 2 Display of pictogram when required by menus

4.3.2 Screen user interface



To navigate in the various menus of the screen, use the black « Tab » navigation pushbutton (diamond pictogram ).

Numerical and alphabetical inputs are made using the black « Increment » pushbutton (square pictogram ).

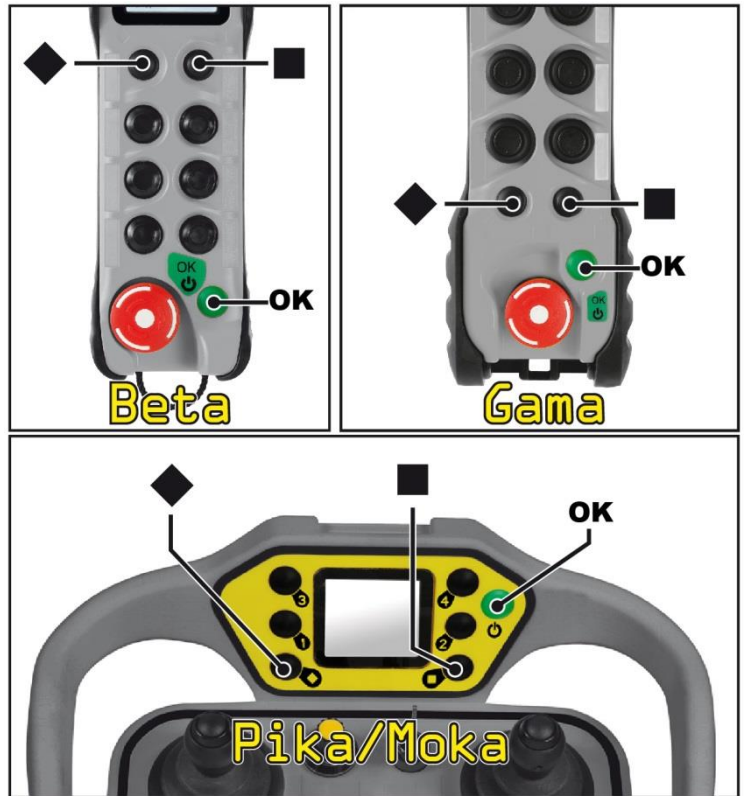
To select menus or validate data, use the green validate pushbutton (round pictogram .



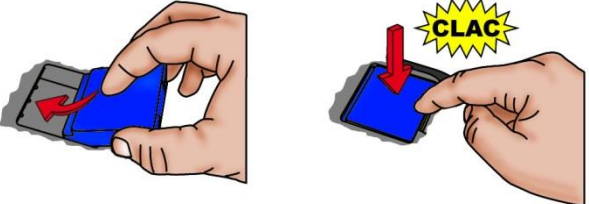
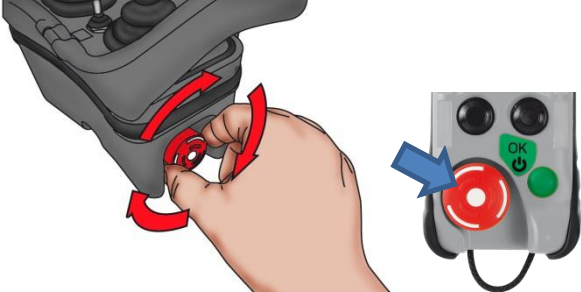

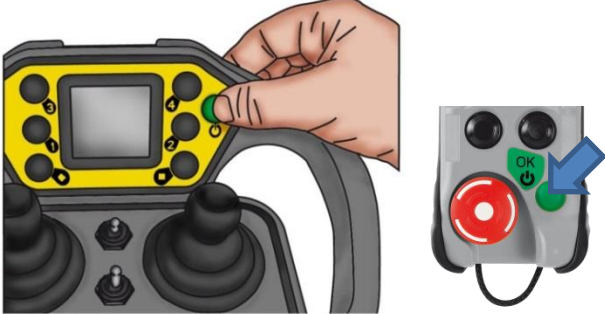
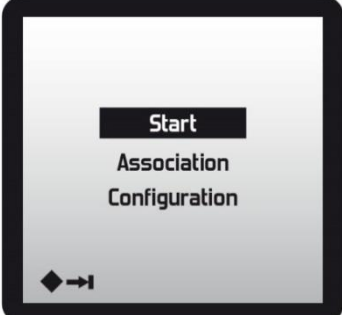
4.4 Commissioning the operator module

1	Install the charged battery (color-coded blue) in the operator module housing.	
2	Unlock the emergency stop palmswitch.	
3	Press and release the green « On » pushbutton  .	
4	The operator module home screen should display the following information.	
5	Description of menus proposed : Start : This menu is used to generate an installation startup command to the Transceiver. IMPORTANT : the association procedure must be completed beforehand. Association : This procedure is carried out during commissioning to associate the Operator module to the Transceiver(s). Configuration : This menu is used to configure certain settings on the radio control system.	
6	Before any use, perform the « ASSOCIATION » procedure detailed in the next section « <i>Association function</i> ».	

4.5 « Association » function (association with a Transceiver)

The « **Association** » function is used to search for and identify the Transceivers located in the vicinity of the operator module and to select one from the list displayed. This function is used to configure the operator module with the application parameters contained in the Transceiver.

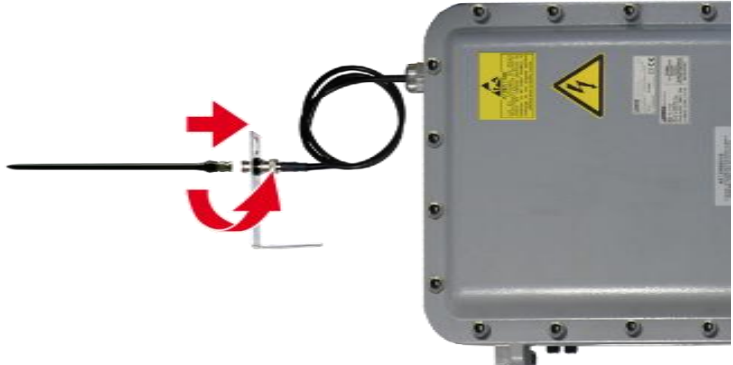
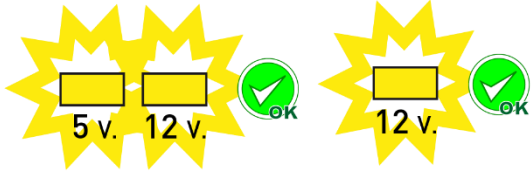
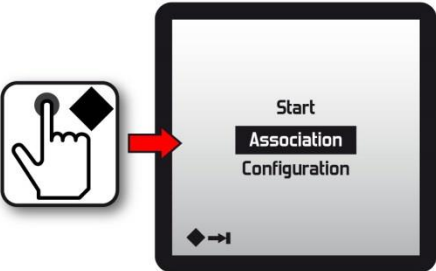
Note : During the Transceiver search phase, the transmit range of the Operator module is reduced to prevent unintentional selection of a Transceiver located outside the user's view.

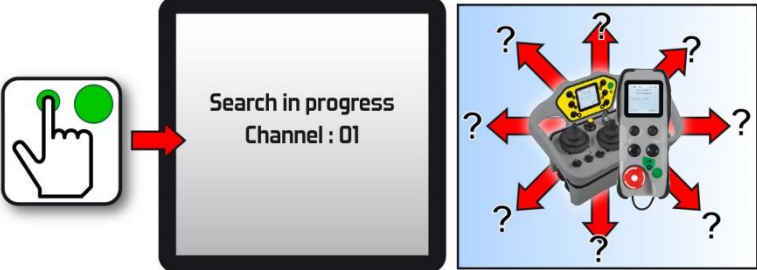
1	Connect the antenna into the BNC connector on Transceiver	
2	Connect the ATEX Transceiver or the ATEX connection interface unit to the electrical power supply and switch on the system. (See section « <i>Instructions for installation and commissioning</i> » for more information concerning electrical connection)	<p style="text-align: center;">Alto Elio</p> 
3	Switch on the operator module and select the « Association » menu on the home screen	
4	Press the green validate pushbutton  to initiate the transceiver search.	 <p style="text-align: center;">The operator module will search for transceivers located in the vicinity on all the available radio channels</p>

4.5.1 Searching for Transceiver

When a Transceiver has been found and identified, the operator module screen indicates :

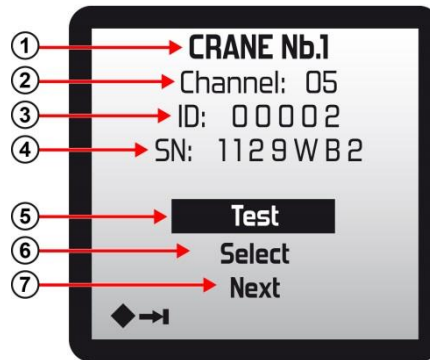

- 1) The name of the radio-controlled equipment
- 2) The radio channel used by the radio-controlled application
- 3) The identity code used for the application
- 4) The serial number of the Transceiver identified
- 5) Choose « **Test** » to test the Transceiver identified before you make a definitive association. This action will generate an activation command to the relay associated to the green validate pushbutton , as :
 - Transceiver **Alto** : the relay **RM** is activated
 - Transceiver **Elio** : the relay **RM** is activated
- 6) Choose « **Select** » to access the menu used to associate the Operator module with the Transceiver identified (see next section « [Associating a Transceiver to an Operator module](#) »)
- 7) Choose « **Next** » to continue the search for the Transceiver on the other radio channels.

If no Transceiver has been found or identified, the « **No Transceiver Module** » message displayed. You must press the emergency stop palmswitch.

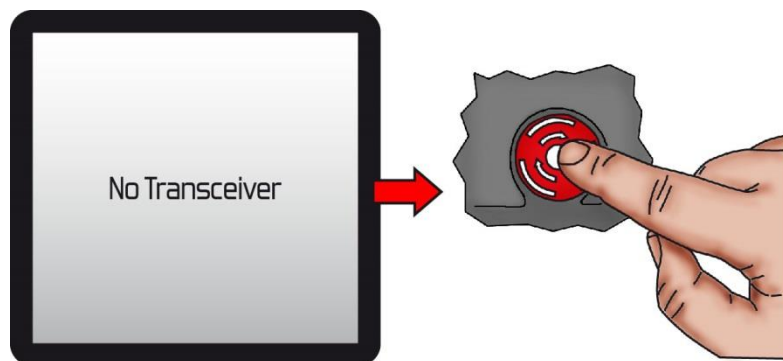

4.5.2 Associating a Transceiver to an Operator module

Once the Transceiver search has been successfully completed (see previous section), use the « **Select** » menu to associate the Operator module with the Transceiver.



Choose « **Previous** » to return to the Transceiver search function.

Chose « **Transfer** » to initiate the association procedure during which the application configuration parameters contained in the Transceiver are transmitted by radio to the Operator module.

IMPORTANT : Do not switch off the Transceiver power supply during this step.

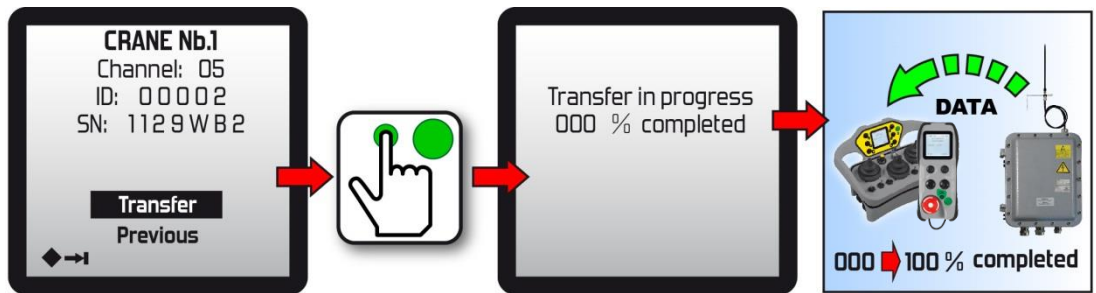

The operator module will then Synchronise the data saved in the operator module. Once the check is completed, if the procedure has taken place correctly, the « **Parameters OK** » message is displayed and by choosing « **Validation** », the operator module power supply is switched off :

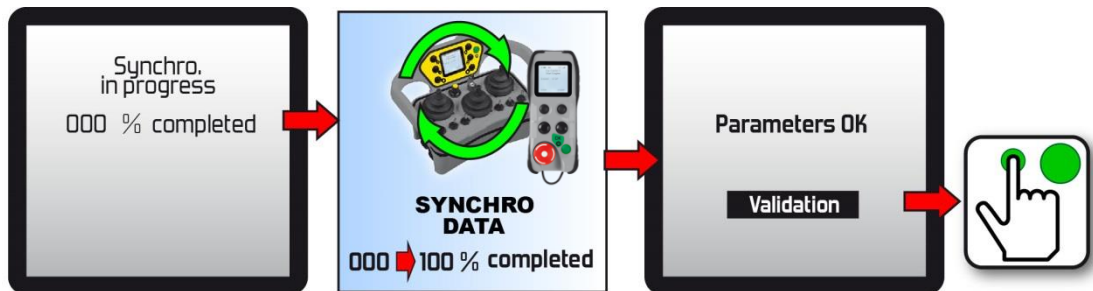





Note : The maximum time required for an association is around 3 minutes.

Note : It is possible to secure (prohibit or authorise) the " **Association** " function with a PIN code. See the **iDialog** software documentation ref 351910.

4.6 Using the radio control system

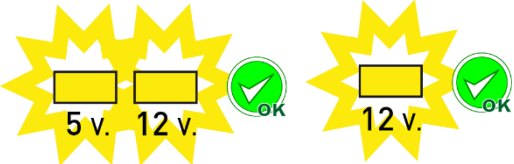
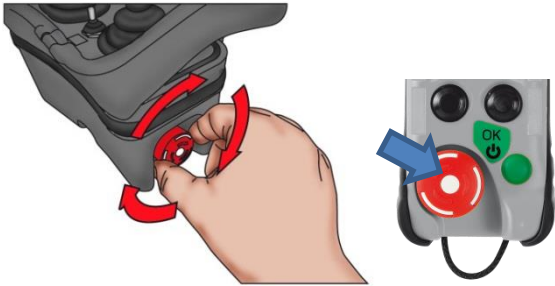
4.6.1 Starting up the radio control system

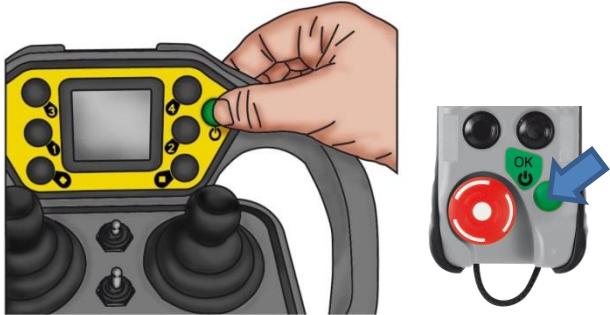
IMPORTANT : Before using the system, make sure the Operator module has been associated with a Transceiver ; proceed as instructed in the « **Association Function** » section.

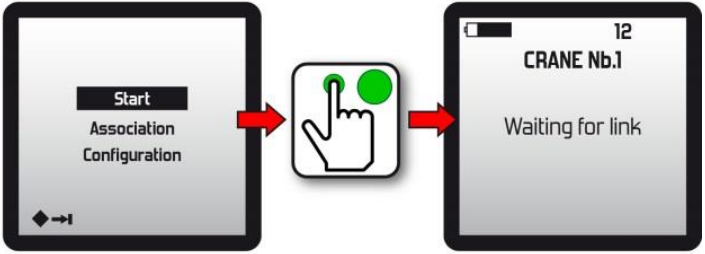
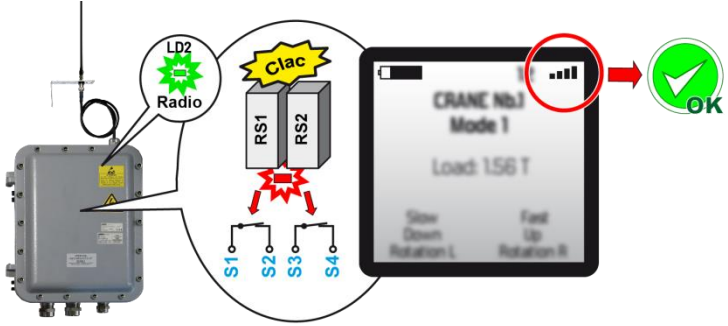
<p>1</p>	<p>Switch on the Transceiver</p>	<p style="text-align: center;">Alto Elio</p> 
<p>2</p>	<p>Unlock the emergency stop palmswitch.</p>	
<p>3</p>	<p>Press and release the green « On » pushbutton .</p>	
<p>4</p>	<p>Select the « Start » menu on the home screen and press the green « On » pushbutton .</p>	
<p>5</p>	<p>Once the link between the Operator module and the Transceiver has been set up, the safety relays of the Transceiver are activated (RS1 and RS2).</p> <p>The equipment can be radio-controlled.</p>	

If the radio link has not been established within 8 seconds, the following message is displayed:



Press the « On » validate button  to return to the operator module home screen.

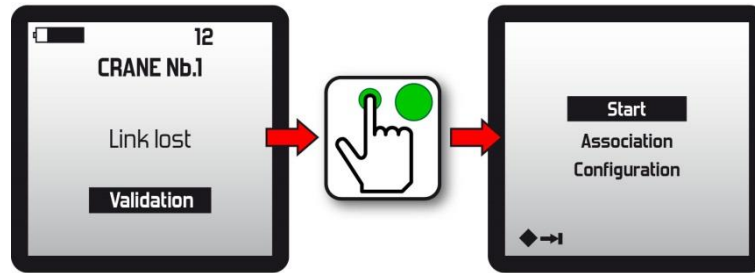

Note : During use, if no control component has been actuated over a certain period of time, the "Standby Mode" function is triggered, causing the operator module to stop and passive stopping of the Transceiver.

Refer to section « [Operator module automatic stop function](#) ».

Note : Access to the "Start", "Association" and "Configuration" menus can be protected by a PIN code. See the **iDialog** software documentation ref 351910.

4.6.2 Stopping the operator module

1

To fully stop the operator module, press the emergency stop palmswitch.

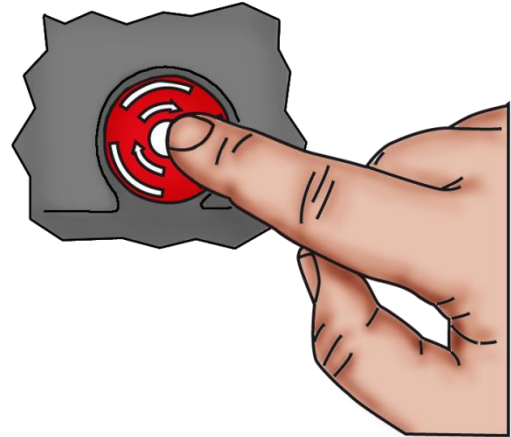

2

Before shutting down, the operator module generates an « active » priority stop command to the Transceiver (active stop).

To reactivate the operator module after the emergency stop palmswitch has been pressed, perform the « Startup » procedure detailed in the previous section.

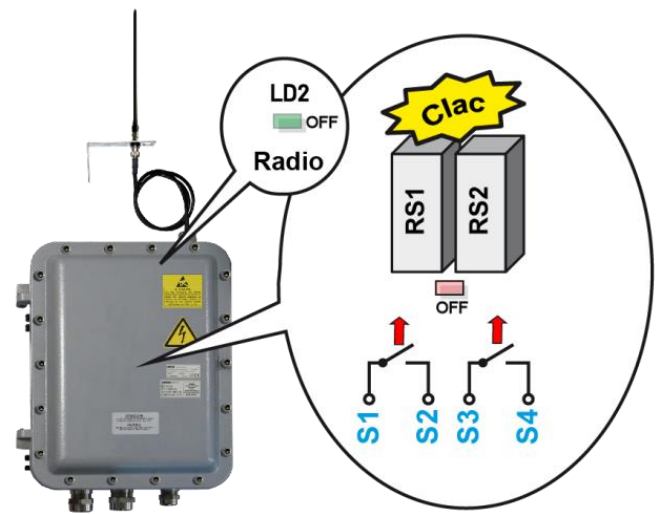

Note : The operator module can also be stopped by the « **Standby Mode** » and « **Deadman** » (optional) functions detailed in the section « **Operator module automatic stop functions** ».

4.6.3 Function selector

Depending on the applications and utilisation needs, certain pushbuttons on the operator module are configured to operate as function « **selectors** ».

Depending on the operator module, up to 6 selectors can be implemented.

When a pushbutton on the operator module is used in « selector » mode, the function is the function shown on the screen in the “selection designation” areas.

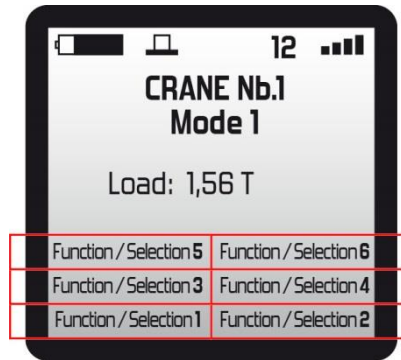

Each time the « selector » pushbutton is pressed and released, the screen displays the next function and transmits it to the Transceiver.

Example :

Pushbuttons **F1** and **F2** of an operator module have been configured in selector mode. Below is the operating principle when pushbutton **F2** is pressed (sequential lighting control) :

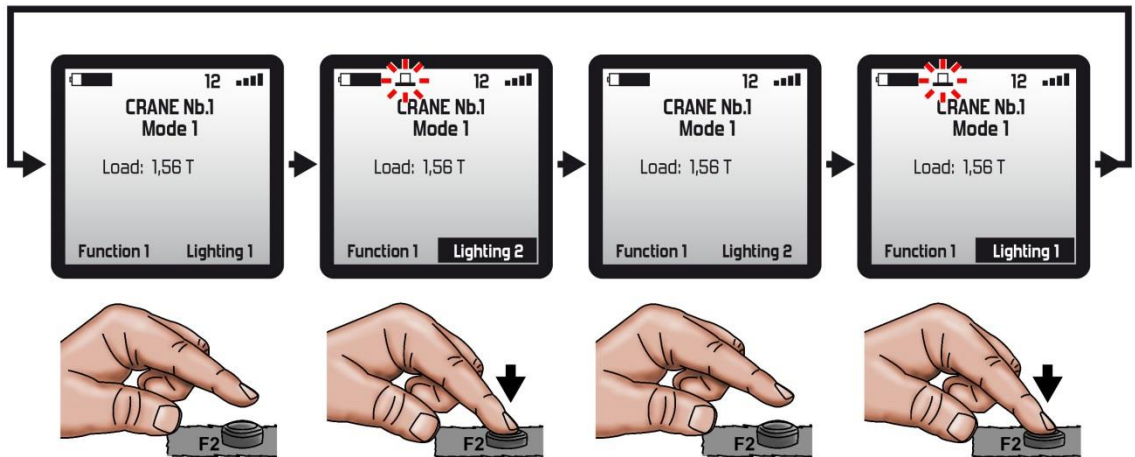

Note : The pushbuttons configured as selectors and the correspondence with the designation areas are indicated on the **configuration sheet** supplied with the radio control system

Note : The function and selection designations can be modified using the **iDialog** configuration software.

4.7 Alert messages

While using the operator module, alert messages or pictograms can appear on the screen. These messages are displayed to inform you on a given situation and to guide you in certain cases to re-establish operation. Depending on the "hardware" options of the product, it is possible to activate a buzzer when the alert message appears on the operator module screen (activation is done with the **iDialog** programming software).

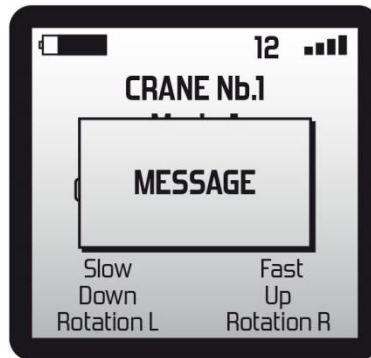

List of messages :

Message or pictogram	Description	Display time
	The standby function is going to be activated since the operator module has not been used over a certain period of time.	Momentary. This message appears for 30 seconds before automatic shutdown of the operator module
	The battery level is low. The battery must be recharged or replaced.	Momentary. This message appears several times before shutdown of the operator module (battery discharged).
	The Transceiver is in « safety » mode. The safety relays have been deactivated.	Permanent, up to reactivation of the Transceiver (by pressing the « On » button on the operator module).
	A change of parameter could not be synchronised with the Transceiver (not acknowledged).	Momentary.
	Low radio link level between operator module and transceiver	Momentary
	A fault has been detected on actuation of a control component	Each time the concerned control component is actuated
	Dead man function Pre-alarm : This message indicates that the system will be put into "safety" mode if no control component is activated (or previously defined Dead man button)	Momentary (adjustable with iDialog software)
	The operator module parameters saved in the Transceiver memory differ from those saved in the operator module memory.	Permanent, when starting the operator module (the application's data must be reprogrammed into the memory of the transceiver and / or the operator module)
	Changing the mode is not possible because a control component is activated (button pressed, joystick handled etc ...)	As long as a control component remains activated

Note 1 : All of the alarm messages can be cleared by pressing the « On » button on the operator module.

Note 2 : Certain messages can be modified using the **iDialog** software.







4.8 Configuration menu

The « **configuration** » menu is used to access the various configurations of the operator module and of the radio control system.

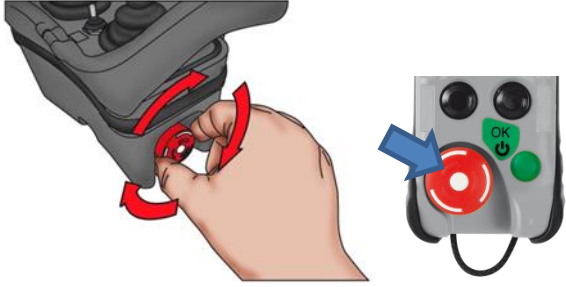
IMPORTANT : certain settings require shutdown of the Transceiver.

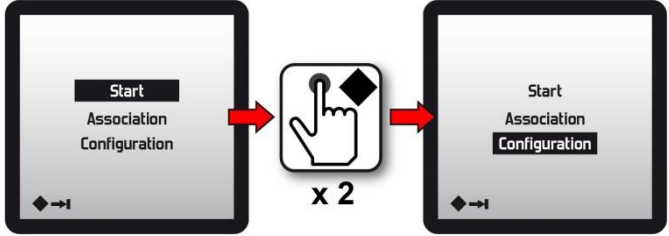
4.8.1 Accessing the configuration menu

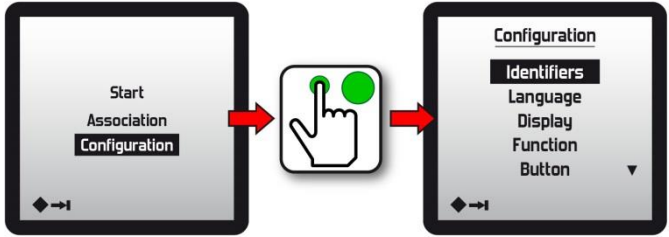
The « **configuration** » menu is accessible on power up of the operator module :

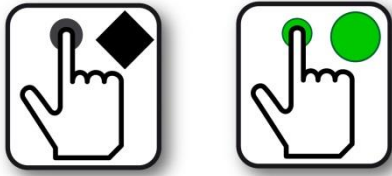
1	Switch on the operator module	
2	Press the black « Tab » pushbutton  and select the « Configuration » menu on the home screen.	
3	Press the green validate pushbutton  to enter the configuration menu.	
4	The choice of parameters to be modified or reviewed is accessible by navigating using the black « Tab » navigation pushbutton  and the green validate pushbutton  .	

4.8.2 Configuration menu summary

The following menus are accessed from the « **configuration** » menu :

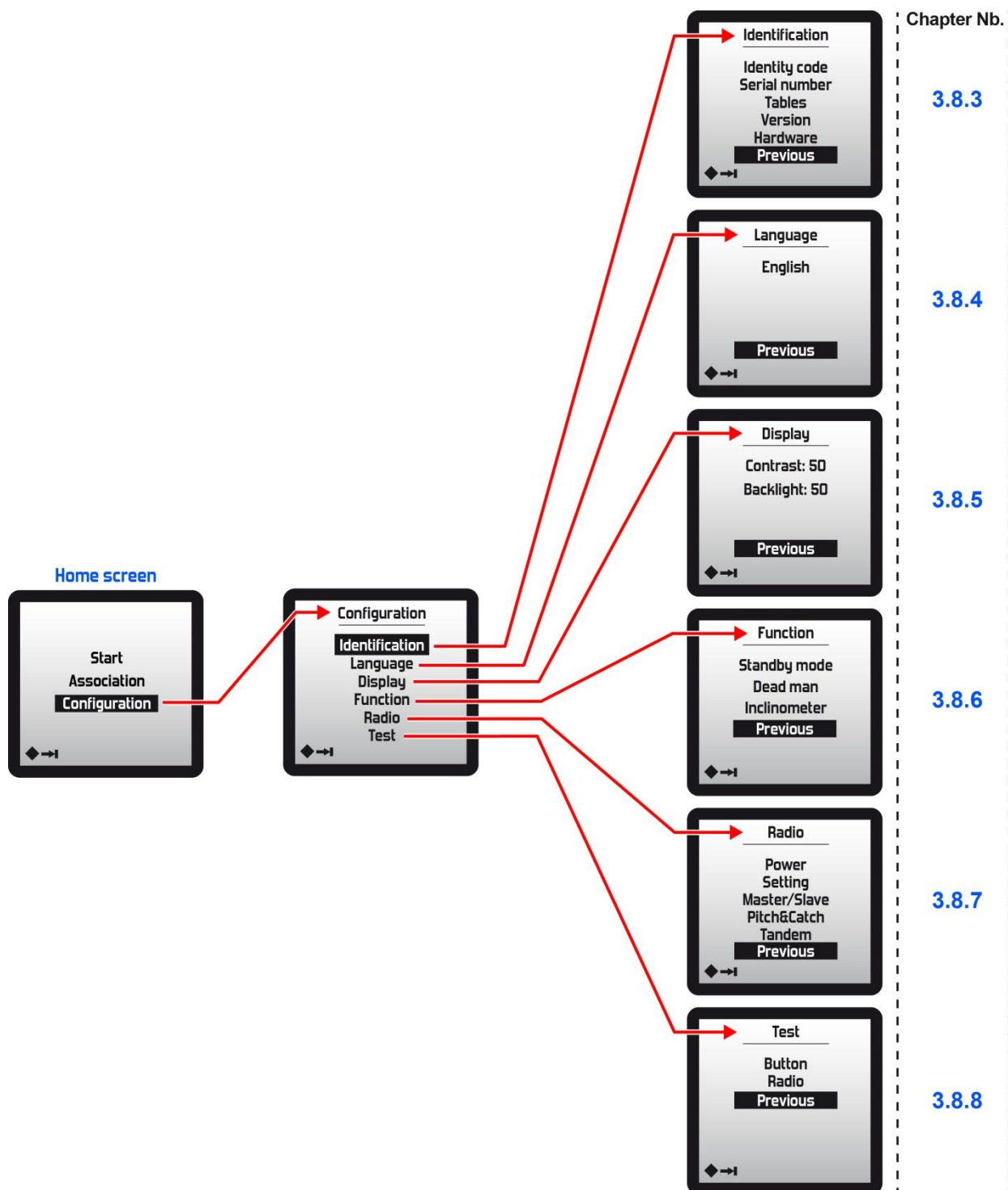

4.8.3 « Identifiers » menu

The « **Identifiers** » menu is used to display certain information of the radio control system such as:

- the **identity codes** of the radio control system,
- the **serial numbers** of Operator module and associated Transceiver,
- the **software version** of the Operator module,

Note : These data can only be viewed (not modifiable).

4.8.3.1 Identity codes

The identity codes of the radio control system are formed by 5 digits ; they are used to link an Operator module to a Transceiver.

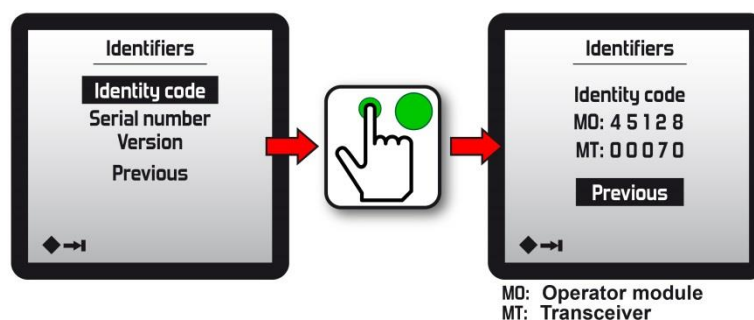

4.8.3.2 Serial numbers

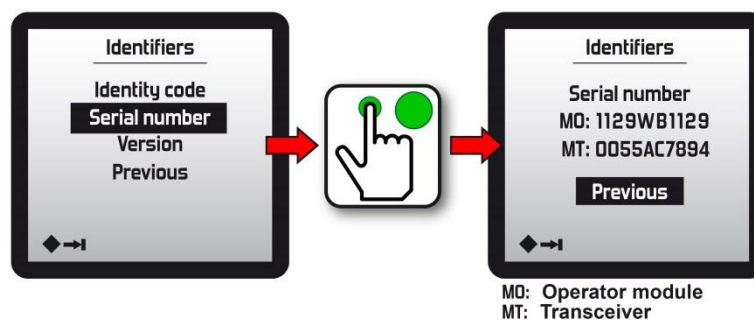

4.8.3.3 Tables

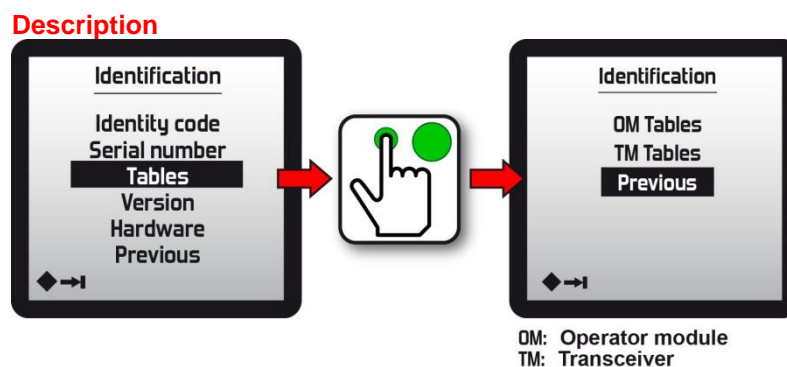

4.8.3.4 Software version of the Operator Module

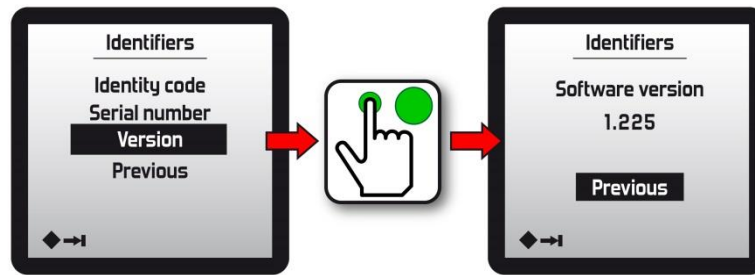

4.8.3.5 Hardware

List of options implemented in the operator module and various related technical data.

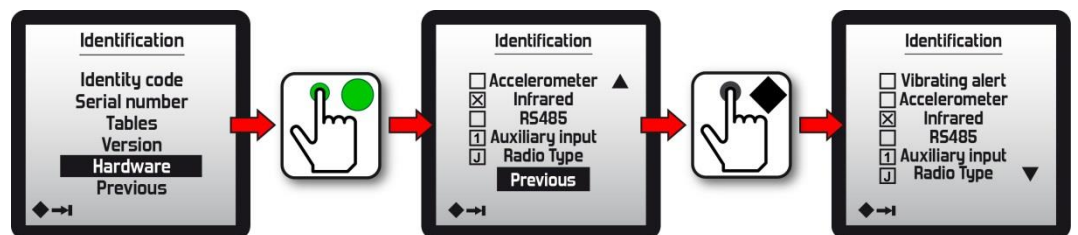





4.8.4 « Language » menu

This menu is used to change the language used by the Operator module screen.

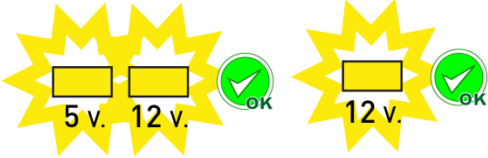
The following languages are available : **French, English, German, Spanish, Italian, Chinese, Dutch, Russian, Kazakh** (non exhaustive list).

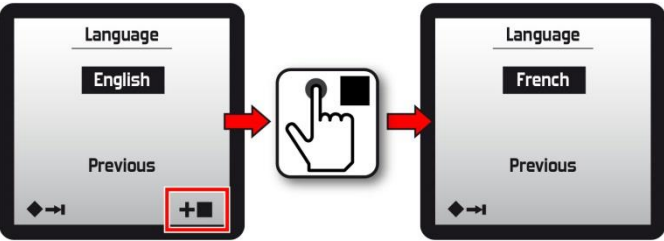
IMPORTANT : The **Transceiver** must be **switched on** in order to change the language.

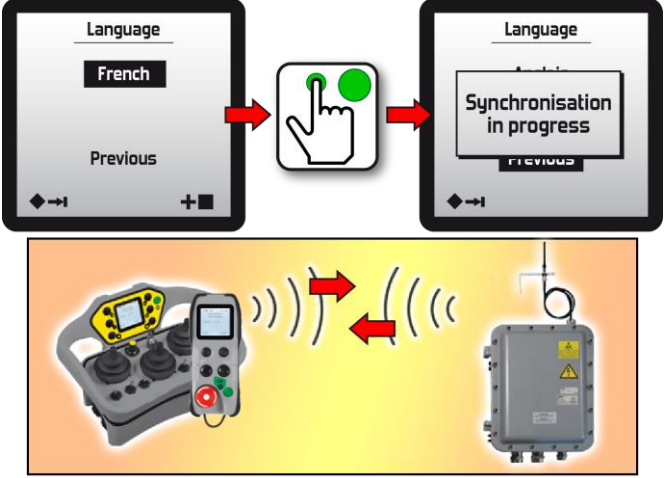
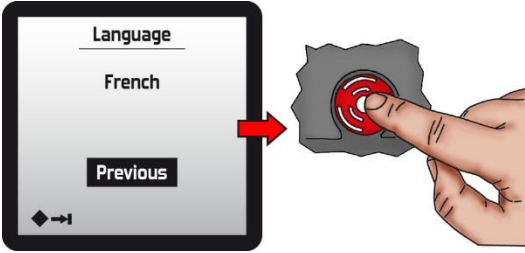
<p>1</p>	<p>Switch on the Transceiver</p>	<p>Alto Elio</p> 
<p>2</p>	<p>Select the current menus language using the « Tab » navigation button .</p> <p>Change the language selection using the black « Increment » pushbutton .</p>	
<p>3</p>	<p>Once you have chosen the new language, press the green validate pushbutton .</p> <p>The Operator module will transmit, by radio, the language configuration change to the Transceiver (Synchronisation in progress message)</p>	
<p>4</p>	<p>Once the data synchronisation is completed, press the emergency stop palmswitch.</p> <p>The next time you startup the operator module, the new language will be displayed on the screen.</p>	





4.8.5 « Display » menu

The « **Display** » menu is used to set the screen parameters, such as :

- the **contrast**,
- the **backlighting**,



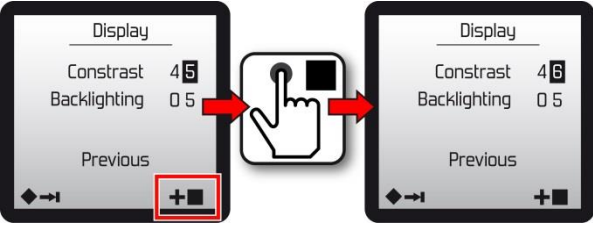

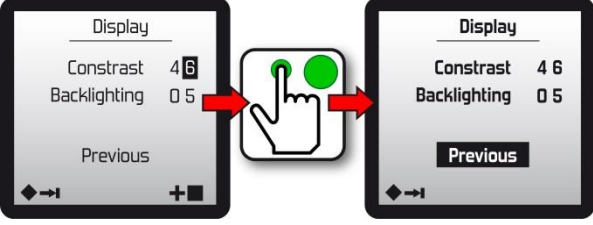
4.8.5.1 Contrast

Note : The screen contrast can be set between **40** and **99**.

1	<p>Select the contrast value using the « Tab » navigation button .</p> <p>Change the value using the black « Increment » pushbutton . Each time you press this button, the digit selected is incremented.</p>	
2	<p>Once you have selected the desired value, press the green validate pushbutton . The Operator module saves and applies the setting.</p>	

4.8.5.2 Backlighting

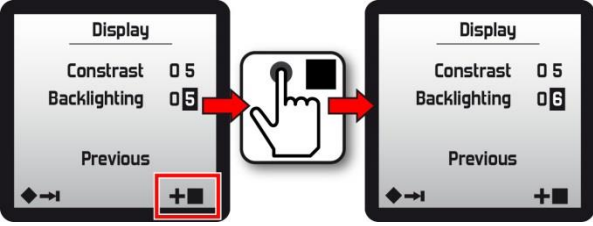
Note : The screen backlighting can be set between **00** (deactivated) and **99**.

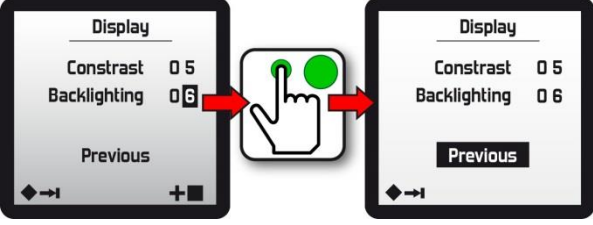
1	<p>Select the backlighting value using the « Tab » navigation button .</p> <p>Change the value using the black « Increment » pushbutton . Each time you press this button, the digit selected is incremented.</p>	
2	<p>Once you have selected the desired value, press the green validate pushbutton . The Operator module saves and applies the setting.</p>	

4.8.6 « Function » menu

This menu is used to configure and activate certain Operator module functions.

The function activated by default is : « **Standby Mode** » (This function is described in the section « **Automatic stop functions** »).

IMPORTANT : The **Transceiver** must be **powered up** in order to modify the function settings.

4.8.6.1 Standby

Note : The timeout prior to automatic stopping initiated by the **Standby Mode** function can be configured between **01** and **60**.minutes.
This function is activated by default.

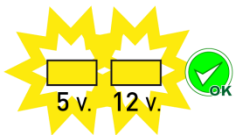
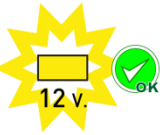
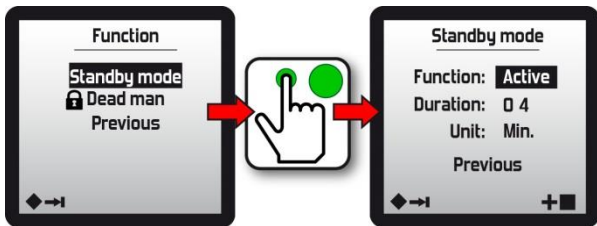
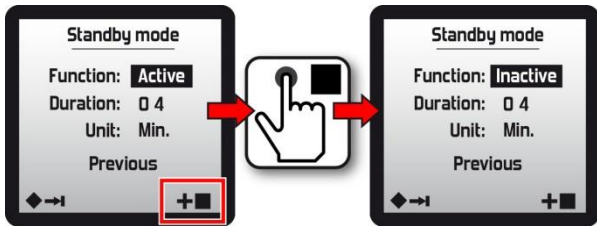
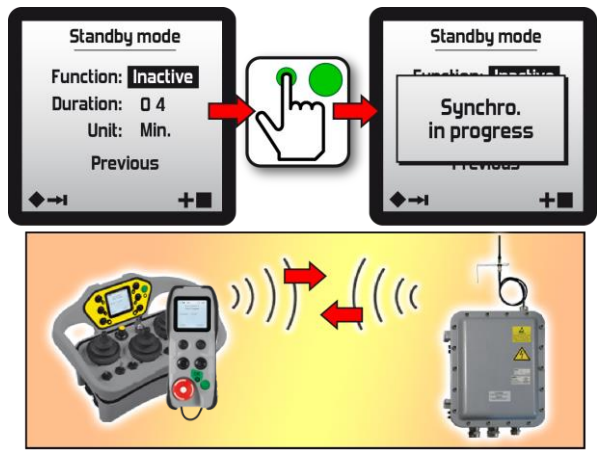
1	Switch on the Transceiver.	<div style="display: flex; justify-content: space-around;"> <div style="text-align: center;"> <p>Alto</p>  </div> <div style="text-align: center;"> <p>Elio</p>  </div> </div>
2	In the "Function" menu, select the « Standby mode » function using the « Tab » navigation button (◀→). Validate your choice using the "Validate" button (●).	
3	Select the parameter to be changed using the « Tab » navigation button (◀→). Change the value using the black « Increment » pushbutton (+■). Each time you press this button, the status of the selected field is modified or the selected digit is incremented.	
4	Once you have modified the parameters, press the green validate pushbutton (●). The Operator module will transmit, by radio, the configuration change to the Transceiver (Synchronisation in progress message).	

4.8.6.2 **Dead man**

See chapter « [Options and special functions](#) »

4.8.6.3 **Inclinometer**

See chapter « [Options and special functions](#) »

4.8.7 « Radio » menu

This menu is used to review and configure the radio characteristics of the radio control system.

IMPORTANT: The **Transceiver** must be:

- powered up
- paired with the operator module
- and available to perform the settings

4.8.7.1 Power

This menu is used to modify:

- the **radio transmit power level** of the **Operator module**,
- the **radio transmit power level** of the **Transceiver**

The radio transmit power level can be adjusted to limit the radio control zone as may be required in certain cases.

The radio transmit power can be adjusted between 01 and 15 depending on the frequency range (see table pages 108 to 110).

Warning ! : Too low a value will significantly impact the transmit range ; you must keep in mind the working distance between the Operator module and the Transceiver with respect to your needs.

1	Switch on the Transceiver.	
2	In the "Radio" menu, select the "Power" sub-menu using the « Tab » navigation button (◀→). Validate your choice using the "Validate" button (●).	
3	Select the parameter to be modified using the « Tab » navigation button (◀→). Modify the value using the black « Increment » pushbutton (+■). Each time you press this button, the selected digit is incremented.	<p style="text-align: center;">MO: Operator module MT: Transceiver</p>
4	Once the parameters have been modified, press the green validate pushbutton (●). The Operator module will transmit, by radio, the change of radio power to the Transceiver (Synchronisation in progress message).	

4.8.7.2 Setting the radio channel







This menu is used to configure :

- the **radio transmit mode** of the radio control system,
- the **number of the radio channel** used in the frequency band,

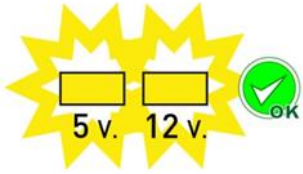
IMPORTANT : The **Transceiver** must be **powered up** and available to perform the following settings.

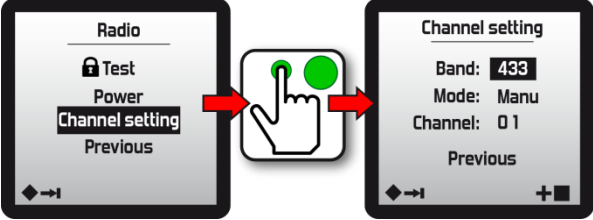
Frequency band	419: 419MHz (11 radio channels available)
	433: 433-434MHz (64 radio channels available)
	869: 869MHz (12 radio channels available)
	911: 911-918MHz (64 radio channels available)
	2.4 : 2.4GHz (64 radio channels available)
Radio emission mode	Auto: <i>Automatic mode</i> At startup, the transmitter searches for the Receiver if it is not present on the current channel.
	Manu: <i>Manual Mode</i> The radio channel can be manually defined for the radio control system.
Radio channel	01 to 11 in 419MHz frequency band.
	01 to 64 in 433-434MHz frequency bands.
	01 to 12 in 869MHz frequency band.
	01 to 64 in 911-918MHz frequency bands.
Baudrate	01 to 64 in 2.4 GHz frequency bands
	It is recommended to use baudrate 4 when WHC is enabled. Caution: Using baudrate 4 restricts the number of available channels

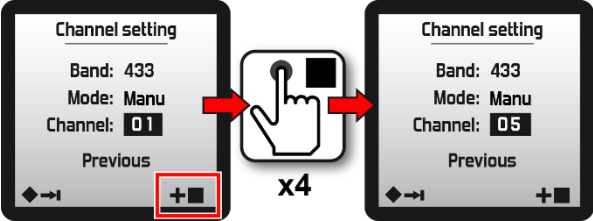
Procedure:

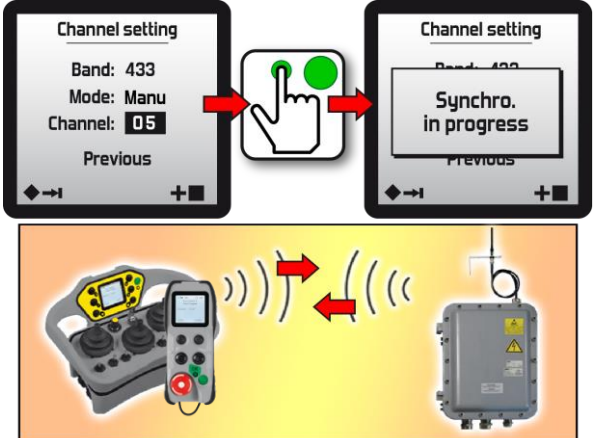
1	Switch on the Transceiver.	<p style="text-align: center;">Alto</p> 
2	In the "Radio" menu, select the "Set channel" sub-menu using the « Tab » navigation button  . Validate your choice using the "Validate" button  .	
3	Select the parameter to be modified using the « Tab » navigation button  . Modify the value using the black « Increment » pushbutton  . Each time you press the button, the status of the selected field is changed or the selected digit is incremented.	
4	Once you have modified the parameters, press the green validate pushbutton  . The Operator module will transmit, by radio, the changes to the Transceiver (Synchronisation in progress message).	

4.8.7.3 List of available radio frequencies

419 MHz band		433-434 MHz bands				869 MHz band		911-918 MHz bands ⁽¹⁾				2,4 GHz bands			
Channel No.	Frequency MHz	Channel No.	Frequency MHz	Channel No.	Frequency MHz	Channel No.	Frequency MHz	Channel No.	Frequency MHz	Channel No.	Frequency MHz	Channel No.	Frequency MHz	Channel No.	Frequency MHz
01	418,975	01	433,1025	33	433,9025	01	911,800	33	915,100	01	2402,00	33	2442,00		
02	419,000	02	433,1275	34	433,9275	02	911,900	34	915,200	02	2403,25	34	2443,25		
03	419,025	03	433,1525	35	433,9525	03	912,000	35	915,300	03	2404,50	35	2444,50		
04	419,050	04	433,1775	36	433,9775	04	912,100	36	915,400	04	2405,75	36	2445,75		
05	419,075	05	433,2025	37	434,0025	05	912,200	37	915,500	05	2407,00	37	2447,00		
06	419,100	06	433,2275	38	434,0275	06	912,300	38	915,600	06	2408,25	38	2448,25		
07	419,125	07	433,2525	39	434,0525	07	912,400	39	915,700	07	2409,50	39	2449,50		
08	419,150	08	433,2775	40	434,0775	08	912,500	40	915,800	08	2410,75	40	2450,75		
09	419,175	09	433,3025	41	434,1025	09	912,600	41	915,900	09	2412,00	41	2452,00		
10	419,200	10	433,3275	42	434,1275	10	912,700	42	916,000	10	2413,25	42	2453,25		
11	419,250	11	433,3525	43	434,1525	11	912,800	43	916,100	11	2414,50	43	2454,50		
		12	433,3775	44	434,1775	12	912,900	44	916,200	12	2415,75	44	2455,75		
		13	433,4025	45	434,2025	13	913,000	45	916,300	13	2417,00	45	2457,00		
		14	433,4275	46	434,2275	14	913,100	46	916,400	14	2418,25	46	2458,25		
		15	433,4525	47	434,2525	15	913,200	47	916,500	15	2419,50	47	2459,50		
		16	433,4775	48	434,2775	16	913,300	48	916,600	16	2420,75	48	2460,75		
		17	433,5025	49	434,3025	17	913,400	49	916,700	17	2422,00	49	2462,00		
		18	433,5275	50	434,3275	18	913,500	50	916,800	18	2423,25	50	2463,25		
		19	433,5525	51	434,3525	19	913,600	51	916,900	19	2424,50	51	2464,50		
		20	433,5775	52	434,3775	20	913,700	52	917,000	20	2425,75	52	2465,75		
		21	433,6025	53	434,4025	21	913,800	53	917,100	21	2427,00	53	2467,00		
		22	433,6275	54	434,4275	22	913,900	54	917,200	22	2428,25	54	2468,25		
		23	433,6525	55	434,4525	23	914,000	55	917,300	23	2429,50	55	2469,50		
		24	433,6775	56	434,4775	24	914,100	56	917,400	24	2430,75	56	2470,75		
		25	433,7025	57	434,5025	25	914,300	57	917,500	25	2432,00	57	2472,00		
		26	433,7275	58	434,5275	26	914,400	58	917,600	26	2433,25	58	2473,25		
		27	433,7525	59	434,5525	27	914,500	59	917,700	27	2434,50	59	2474,50		
		28	433,7775	60	434,5775	28	914,600	60	917,800	28	2435,75	60	2475,75		
		29	433,8025	61	434,6025	29	914,700	61	917,900	29	2437,00	61	2477,00		
		30	433,8275	62	434,6275	30	914,800	62	918,000	30	2438,25	62	2478,25		
		31	433,8525	63	434,6525	31	914,900	63	918,100	31	2439,50	63	2479,50		
		32	433,8775	64	434,6775	32	915,000	64	918,200	32	2440,75	64	2480,75		

Only for Moka and Beta ATEX operator modules and Alto and Elio ATEX transceivers

⁽¹⁾ Warning! For Australia, in the 915 MHz band, only channels 32 (915 MHz) to 64 (918,2 MHz) can be used.

4.8.7.1 Master/Slave

See chapter « [Options and special functions](#) »

4.8.7.2 Pitch&Catch 2.0

See chapter « [Options and special functions](#) »

4.8.7.3 Tandem



See chapter « [Options and special functions](#) »

4.8.8 Test

4.8.8.1 Channel scan

This function allows you to quickly identify the free channels and the occupied channels, which then allows you to configure the frequency of your transmitter / receiver unit on an undisturbed channel.
In order for this test to be most effective, it is imperative to perform the test at the location where the antenna of the receiver will be installed.

Procedure :

In the "Configuration" menu, select function "Test" with navigation button « Tabulation »  and valid choice with "Validation"  button, and select « Channel Scan » function

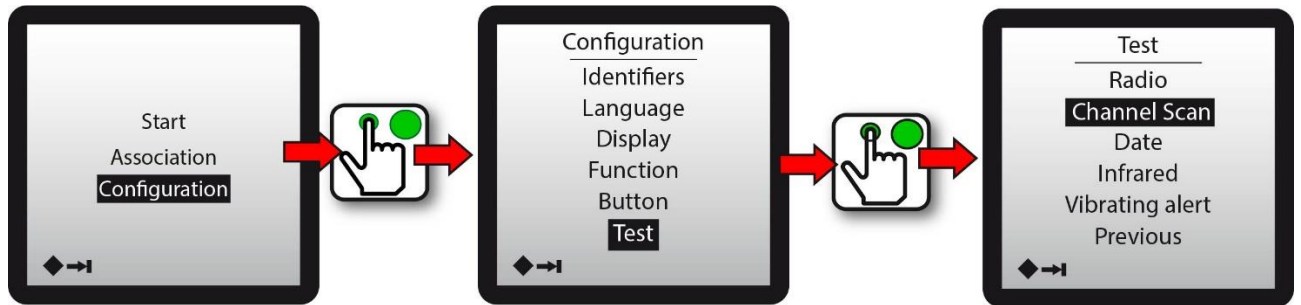

After scanning the entire frequency band, the screen displays a graph with 2 levels of information :

- 1- In black, the maximum band occupancy over the last 5 seconds
- 2- In hatched, the maximum band occupancy since the function was activated. So you can measure for a long time and see intermittent disturbances.

Attention, this function does not replace a spectrum analyzer as the channels are scanned sequentially. A very short disturbance may not be seen.

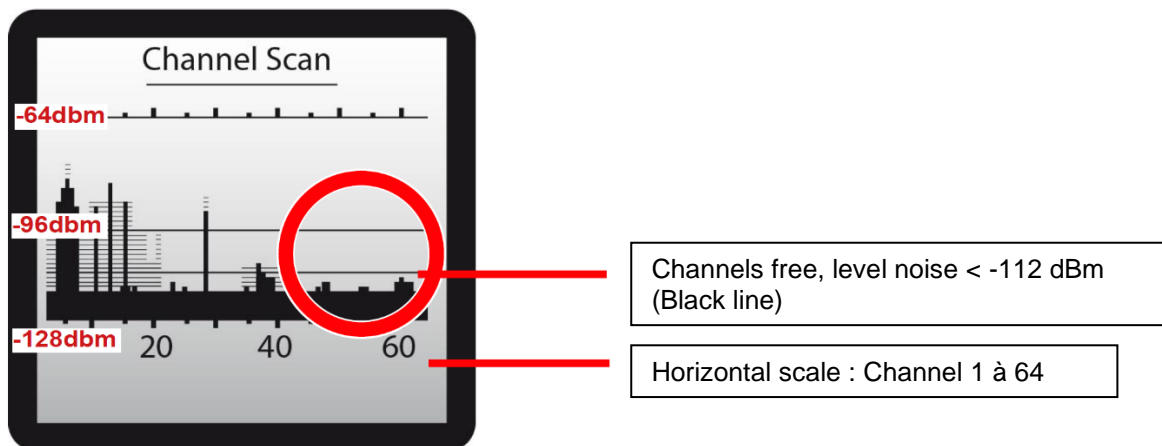

4.9 Operator module automatic stop functions

4.9.1 Standby mode

The operator module is equipped, as a standard function, with the « **Standby mode** » automatic stop function ; this function is linked to the control components.

Operating principle :

The « **Standby mode** » function is activated when the control components of the operator module have not been used over a (programmable) period of time.

10 seconds before activation of the « **Standby mode** » function, the operator module displays the following screen:

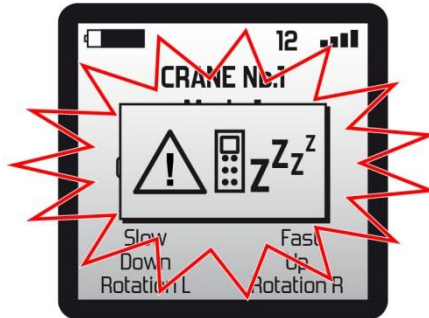

If no action is performed on the control components (pushbuttons) within the 30 seconds, the operator module stops and deactivates the safety relays RS1 and RS2 of the Transceiver.

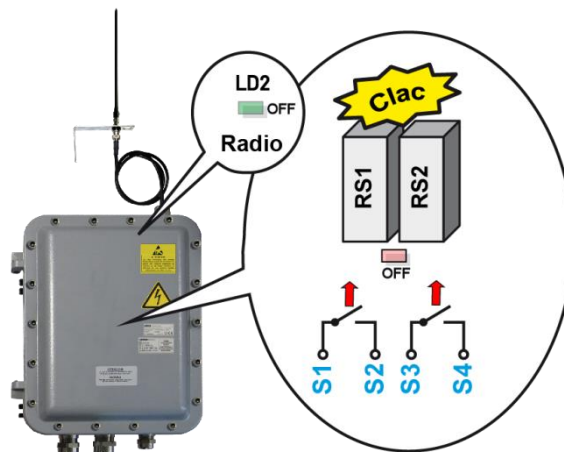

To restart the system, press the "On" button  on the operator module.

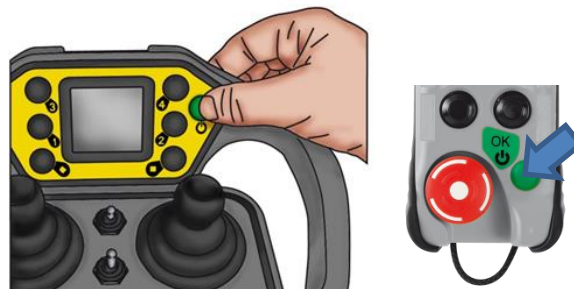

Configuration:

The standby mode function time delay can be configured between 01 and 60 minutes.

This function can be activated or deactivated ; see section [Configuration menu / Function menu](#).

4.9.2 " Deadman"

This function is actuated when the control components have not changed position over a (programmable) period of time

This function can also be associated to a movement sensor, with each detection resetting the programmed duration to zero.

4.10 Default configuration of operator module

Language of screen menus	Language specified on configuration sheet supplied with radio control system
Screen display	<ul style="list-style-type: none">• Contrast: 50• Backlighting: 50
"Standby mode" function	<ul style="list-style-type: none">• Function activated• Time delay before automatic stopping of transmitter: 4 minutes
Radio emission power	<ul style="list-style-type: none">• Transmitter: 08• Receiver: 08
Radio emission mode	Manual
Frequency band	419MHz or 433-434 or 869 or 911-918MHz bands or 2.4GHz (depends on equipment)
Number of radio channel used	Frequency with automatic assignment according to chart
Assignment of control components / receiver outputs	Per application configuration (see configuration sheet supplied with radio control system)
Command interlocking	Per application configuration (see configuration sheet supplied with radio control system)

5 ATEX Battery PYB and PYB2 and battery chargers

WARNING:

THERE IS A RISK OF EXPLOSION IF BATTERY IS REPLACED BY A BATTERY OF AN INCORRECT TYPE. ONLY ATEX BATTERY ref.: PYB (blue color) and PYB2 for MOKA SUPPLIED BY JAY ELECTRONIQUE IS SUITABLE AND CAN BE USED IN EXPLOSIVE ATMOSPHERE. ONLY THE JAY ELECTRONIQUE CHARGERS ARE SUITABLE FOR RECHARGING THE BATTERIES.

-  - DO NOT RECHARGE THE BATTERY OR THE BETA 2 OPERATOR MODULE IN EXPLOSIVE ATMOSPHERE AREA.
- DO NOT EXPOSE THE BATTERY TO TEMPERATURE ABOVE 50°C(122°F).
- DO NOT OPEN OR ATTEMPT TO MODIFY THE BATTERY.

FAILURE TO FOLLOW INSTRUCTIONS MAY CAUSE FIRE OR EXPLOSION. PLEASE RESPECT THE DISPOSE OF USED BATTERIES AS DIRECTED.

5.1 Information on battery storage





The operator module battery must be stored charged with a minimum of charge capacity of 40%. The storage must be in a clean and dry place at room temperature, and in all cases, in accordance with the temperatures specified in chapter [Technical characteristics / Operator modules](#).

Self-discharge is estimated at 10% the first month and then lower (it is mandatory to recharge the battery every 9 months min.).

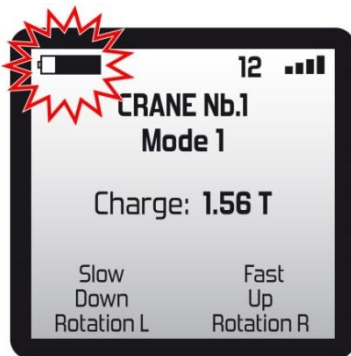
5.2 Operator module battery: charge level











The charge level of the battery in the operator module is displayed on the screen during use:



Symbol	Corresponding level
	Remaining charge > 80%
	Remaining charge between 80% and 50%
	Remaining charge between 50% and 25%
	Remaining charge < 25%
	Battery must be recharged (charge < 10%)

5.3 General view of charger

Given below are the charger and support chargers to be used in accordance with your operator module model :



Type of operator module	Type of battery	Charger and support chargers
<p>Moka :</p>  <p>Pika :</p>  <p>Gama :</p>  <p>Beta 6+4 :</p> 	<p>PYB and PYB2 (for MOKA) :</p> <p><i>Plug-in type</i></p> 	<div data-bbox="1029 672 1444 750" style="border: 1px solid red; padding: 2px; text-align: center;">  DO NOT USE IN ATMOSPHERE EXPLOSIBLE AREAS </div>  <p style="text-align: center;">PWC UBCU</p>
<p>Beta 2+4 :</p> 	<p><i>Internal</i></p>	<div data-bbox="1029 1612 1444 1691" style="border: 1px solid red; padding: 2px; text-align: center;">  DO NOT USE IN ATMOSPHERE EXPLOSIBLE AREAS </div>  <p style="text-align: center;">PWCB02• UBCU</p>

5.4 Information on battery charge

The charging time for an 80% battery charge is 3 h; beyond this time, the charger or support charger delivers a trickle charge.

A 20 min. charge represents around 1h of endurance.

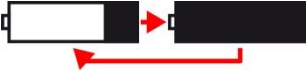
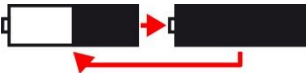
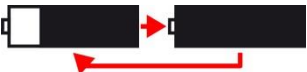
The number of full charge cycles is estimated at 500 cycles min. (with no degradation of the battery).

Symbol (flashing)	Corresponding level
	Start of battery charging Battery charged between 0% and 25%
	Battery charged between 25% and 50%
	Battery charged between 50% and 75%
	Charging complete

Note no 1 : When the Beta 2 operator module is placed on the **PWCB02●** support charger, the battery level charge is indicated on the display screen of the operator module.

Note no 2 : Under low (negative) temperature operating conditions, you may observe an endurance loss of 20%. The operator module is however equipped with an internal sensor which accurately indicates the remaining battery endurance regardless of the operating conditions.

5.5 Indicator light on PWC charger and PWCB02● support charger



The red indicator light on the **PWC** charger gives information on the charge or a message in the event of a malfunction :

RED indicator light	GREEN indicator light	Description
OFF	ON	Battery charge complete
ON	OFF	Temperature fault or no power supply
OFF	OFF	Charging fault (electronic malfunction)

5.6 Supply of chargers

The chargers can be supplied in different ways as described below.

Note : The chargers must be opened to connect the power supply ; a cover plate is provided for this purpose.
Use a Pozidriv **PZ2**. screwdriver.

5.6.1 Power supply by voltage adapter

Adapter ref.: **UBCU** 115-230VAC/12VDC.
Ref. manufacturer : SK01G- 1200050Z (SIMSUKUIAN)
AC entrance : 100-240 Vac 50/60Hz
DC exit : 12Vdc - 0.5A

Only this adapter model can be used with PWC

- 1- Remove the housing cover.
- 2- Connect the **UBCU** supply plug to the internal connector of the charger.
- 3- Close the housing, taking care not to pinch the cord.

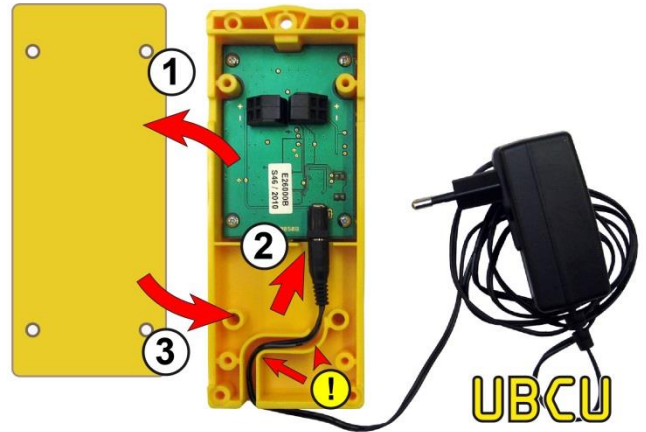

5.6.2 Power supply by external source

The power supply must provide a regulated, stabilised voltage of **12-24VDC 7w min - type PS1 (< 15W)**..

The power supply is connected on a terminal strip with 2 spring-type terminals inside the charger (wire section 0.08mm² to 2.5mm² max.)

- 1- Remove the housing cover.
- 2- Connect the wires of the external power supply to the internal terminal block.
- 3- Close the housing, taking care not to pinch the wires.

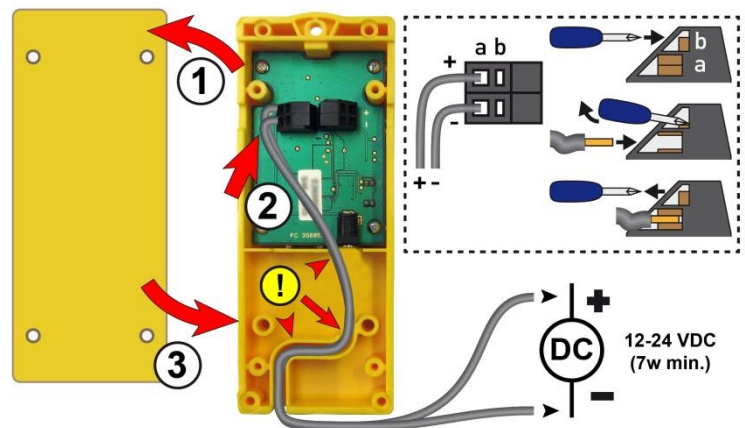

5.7 Options on PWCB021 charger



OPTIONS (RELAYS, BUZZER) ARE NOT INTENDED FOR USE IN EXPLOSIVE ATMOSPHERE AREAS. ONLY THE OPERATOR MODULE IS SUITABLE FOR USE IN EXPLOSIVE ATMOSPHERE AREAS.



RELAYS SHOULD NOT BE USED FOR CONTROLLING ELEMENTS LOCATED IN EXPLOSIVE ATMOSPHERE AREAS.

Chargers equipped with "all options" allow to detect and alert the user about the presence or absence of Operator module on the support.

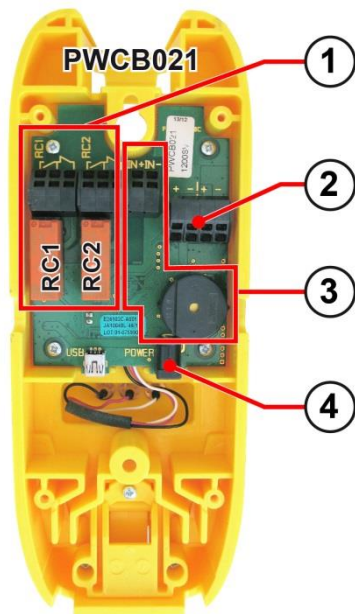

1	Relays RC1 and RC2 : When the Operator module is charging on the support charger, the relays RC1 and RC2 are activated (change-over contacts).
2	Connector for external power supply (regulated, stabilised voltage of 12-24VDC)
3	Internal Buzzer : When a voltage is applied into the digital input (terminals IN + and IN-) and the Operator module is absent from the support charger, the internal buzzer is activated for 1 minute.
4	Supply plug for voltage adapters UBCU

Terminal block wiring

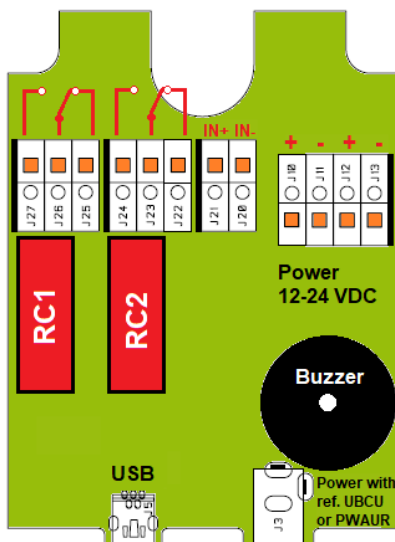

PWCB021, PWCB061

Relays RC1 and RC2 characteristics:

Contacts	AgNi 0,15
Maximum power at cosphi=1	2000 VA
Max. current / voltage switching	8 A / 400 VAC
Min. current / voltage advised switching	50 mA / 12 VDC
Switching cycles at 250 VAC, 8 A, cosphi=1	100 000
Switching cycles at 24 VDC, 8 A	50 000
Tests per EN 60947-5-1	DC13 at 0,5 A / 24 VDC AC15 at 3 A / 250VAC

Digital input characteristics :

Low level on opto-coupler input	DC Voltage < 2 V
High level on opto-coupler input	DC Voltage > 3 V
Maximum voltage level on an input with no damage	30VDC

Applicable models: PWCB022

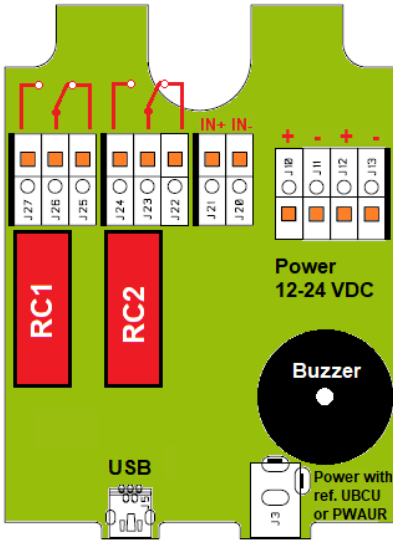

PWCB021, PWCB061

1	Relay RC1 : When the transmitter is charging on the charger support, the RC1 relay is activated (changeover contacts).
2	Connector for external power supply (regulated, stabilised voltage of 12-24VDC)
3	Internal Buzzer : When a voltage is applied into the digital input (terminals I1S to I4S) and the Operator module is absent from the support charger, the internal buzzer is activated for 1 minute
4	Supply plug for voltage adapters UBCU

Wiring diagram example with the use of support charger « all options » on a vehicle

If the Operator module is not present on the support charger when starting the vehicle, the internal buzzer is activated for 1 minute and a warning light comes on (ideally located in the cockpit of the vehicle).

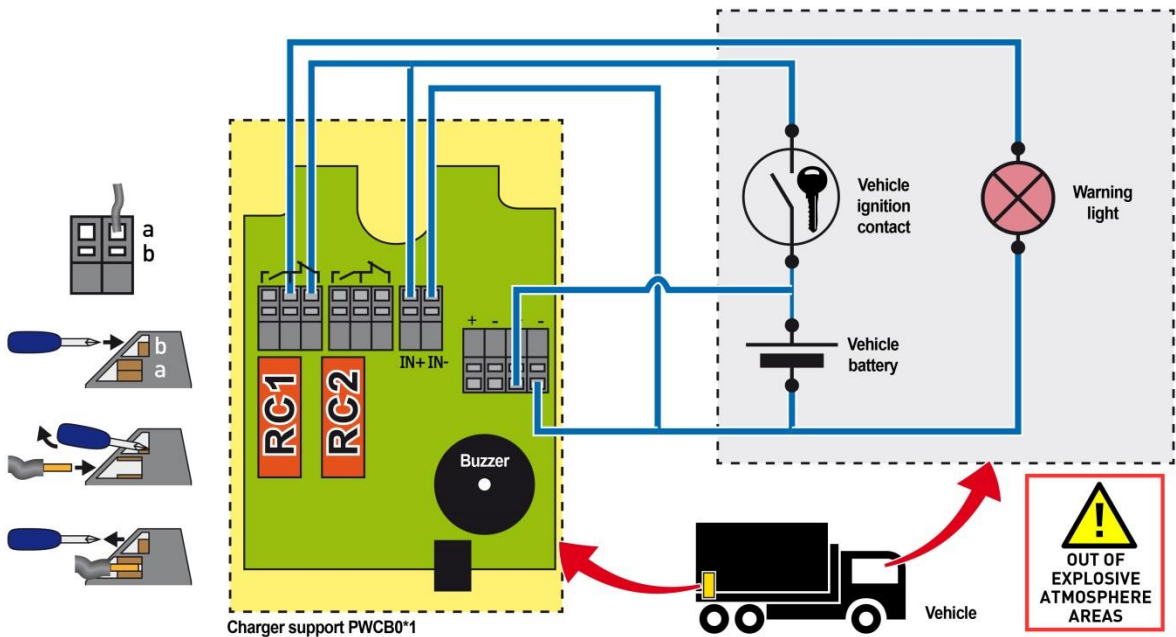

Relays RC1 and RC2 characteristics:

Contacts	AgNi 0,15
Maximum power at cosphi=1	2000 VA
Max. current / voltage switching	8 A / 400 VAC
Min. current / voltage advised switching	50 mA / 12 VDC
Switching cycles at 250 VAC, 8 A, cosphi=1	100 000
Switching cycles at 24 VDC, 8 A	50 000
Tests per EN 60947-5-1	DC13 at 0,5 A / 24 VDC AC15 at 3 A / 250VAC

Digital input characteristics (IN+, IN-):

Low level on opto-coupler input	DC Voltage < 2 V
High level on opto-coupler input	DC Voltage > 3 V
Maximum voltage level on an input with no damage	30VDC

5.7.1 Mounting charger bracket PWCB021, PWCB022

The support charger bracket is for use of wall or work plan.

Position the mounting charger bracket and fix it by means of two or three screws depends on model. The diameter of the fix holes is 5mm for all models.

Secure the wall mounting charger bracket to the structure by using screws (not provided). Ensure that is solidly fixed.

Weight information

- PWCB021, PWCB022: 400 g.

5.7.1.1 Attaching the support charger

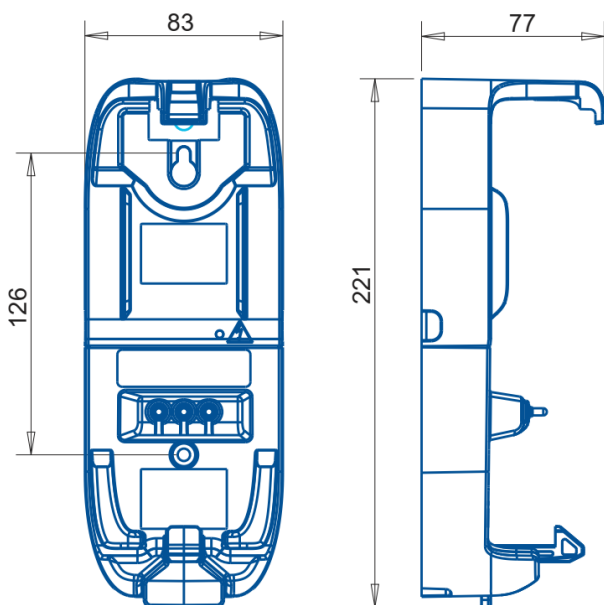

PWCB021, PWCB022
2 x M5 screws

6 ATEX Transceivers and ATEX Connection interface unit

6.1 Explosion-proof housing for Transceivers

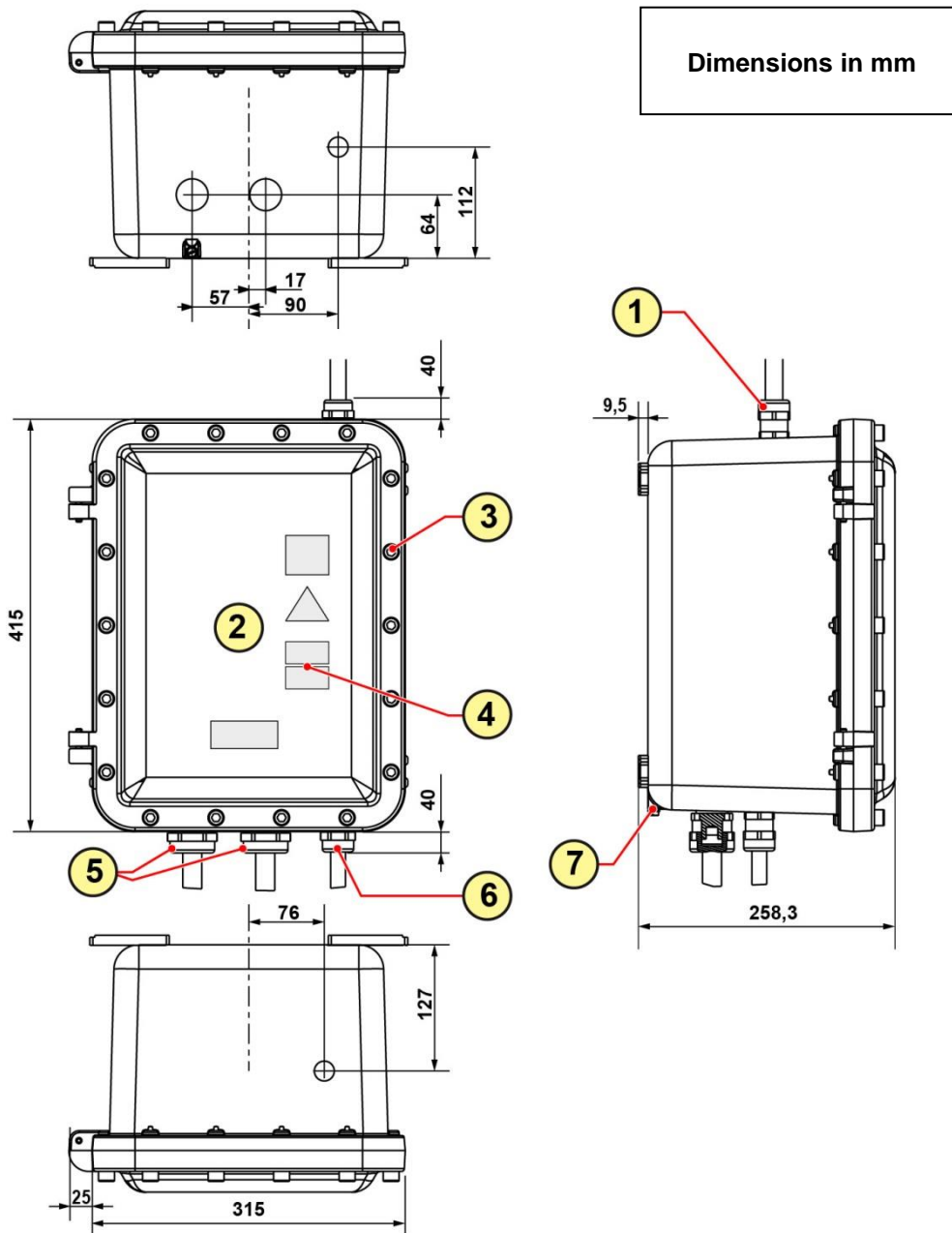

1	Antenna BNC / antenna extension connector
2	ATEX Explosion-proof housing
3	18 housing screws
4	Nameplate and ATEX / IECEx marking
5	2 x PG 1 " NPT Size 32 cable glands for armoured cable (passageway for control cables / power supply) (one is optional)
6	1 x PG 1/2 " NPT Size 20 cable gland (option)
7	Earth connection (see chapter « installation / earth wiring »)

6.2 Transceiver Alto ATEX : internal view

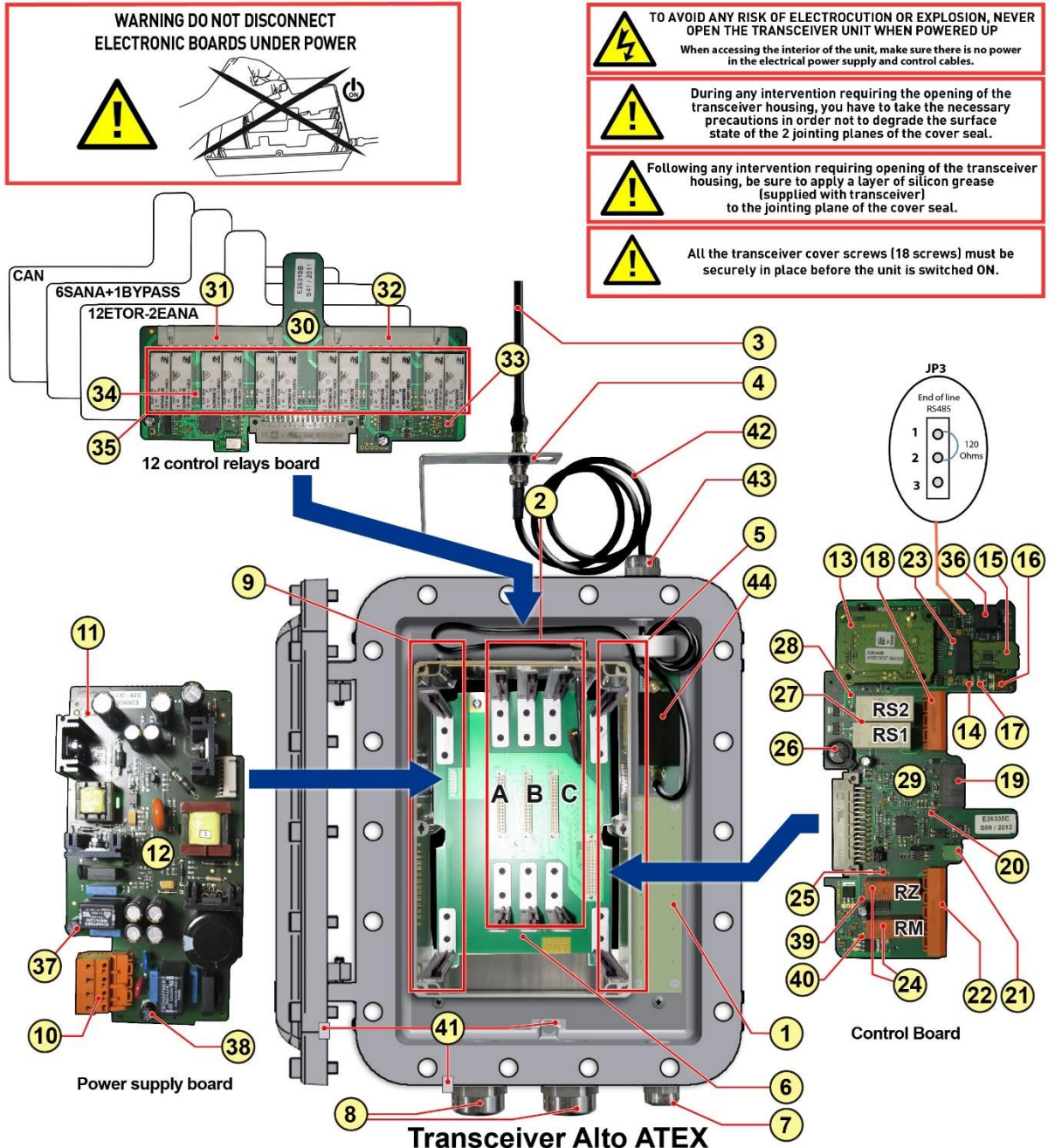

1	Separation circuit option with intrinsically safe connection for Operator module with Alto cable link.	23	Yellow indicator lights 3,3V : Control board power supply OK
2	Positions for Input/Output board (Slot A, B, C)	24	Relays RM and RZ
3	Antenna (BNC connection)	25	Red indicator light LD1 : Diagnostics
4	Mounting bracket with insulated BNC/BNC connector	26	Backup battery (daily time stamping of events)
5	Position for control board	27	Safety relays RS1 and RS2
6	Motherboard	28	Red indicator light : status of safety relays RS1 and RS2
7	1 x 1/2 " cable gland (option)	29	Control board
8	2 x 1 " cable glands (passageway for control cables / power supply) (one is optional)	30	Additional board, « 12 control relays »
9	Position for power supply board	31	Connector for relay outputs R1 to R6
10	Power supply connector for Alto Transceiver	32	Connector for relay outputs R7 to R12
11	Yellow indicator lights 12V and 5V: board power supply OK	33	Red and green indicator lights: Relay board status (red=fault)
12	Power supply board	34	Red indicator light : status of function relays
13	Bidirectional radio module	35	Function relays
14	Green indicator light LD2 : Radio reception + Diagnostics	36	Terminal strip (Analogue input 1, RS485, +5VDC output, etc.)
15	SIM card (system configuration backup)	37	Fuse FU1 (250V@T3.15A)
16	USB connector (configuration and diagnostics)	38	Fuse FU2 (250V@T500mA)
17	Red indicator light LD3 : Diagnostics	39	Red indicator light : status of RZ relay
18	Connector for safety relay outputs	40	Red indicator light : status of RM relay
19	N/A	41	3 Earth connection to be connected
20	Red indicator light for active On/Off input	42	Antenna extension cable (3m)
21	Terminal strip for relays ETOR	43	1 x 1/2 " cable gland antenna cable output
22	Terminal strip for relays RM and RZ	44	Intrinsic safety barrier for antenna output

6.2.1 Wiring terminal strips of Alto ATEX Transceiver

Note : The match-up between the Operator module control component commands and the Transceiver relays is given on the configuration sheet supplied with the radio control system.

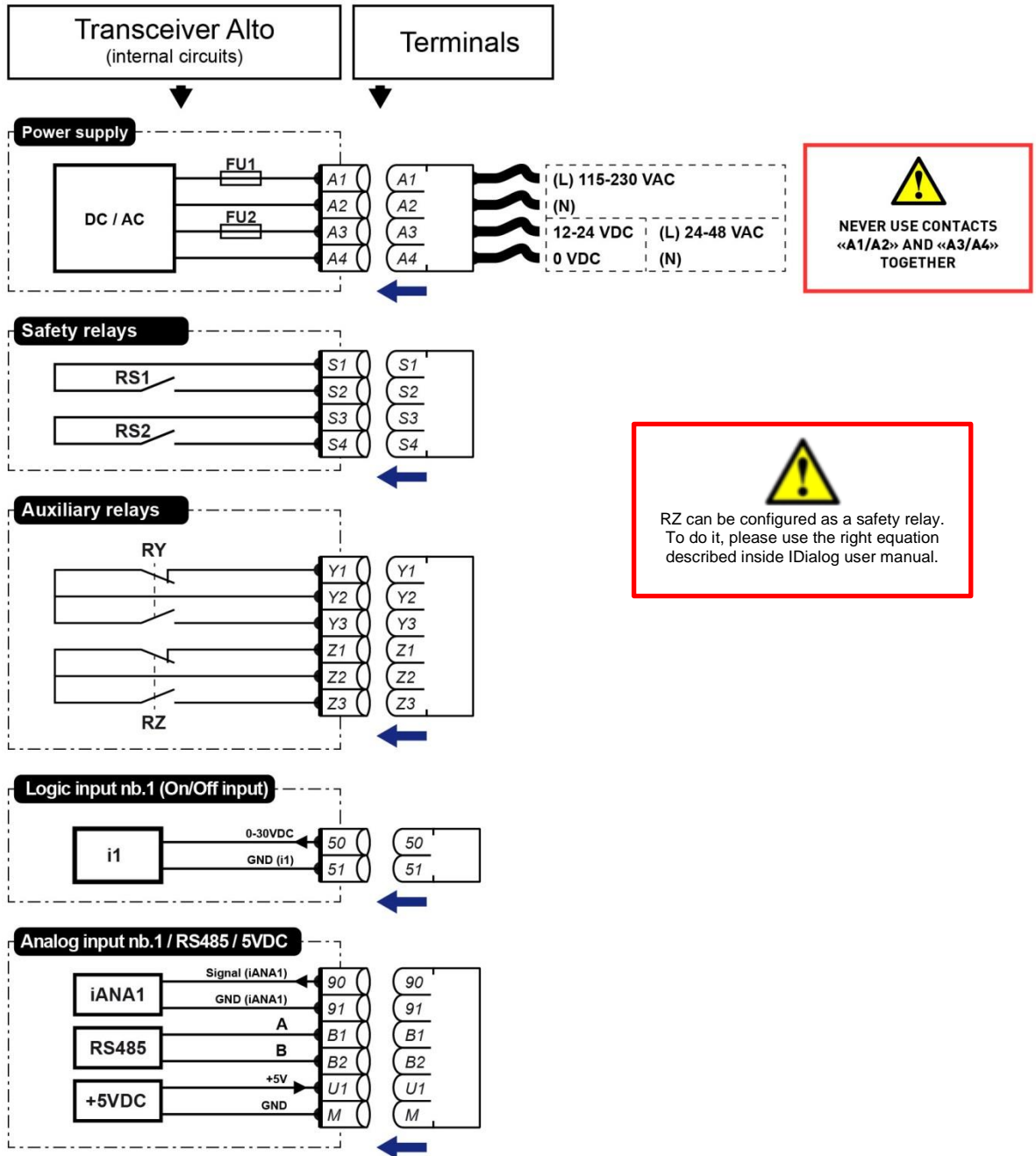

RS485 line termination (jumper JP3):

Jumper JP3 / 1-2	RS485 end of line at 120 Ohms - Modbus Network Termination
Jumper JP3 / 2-3	RS485 end of line at 1.5 kOhm - Termination Wired Link

6.2.2 Board with 12 control relay outputs

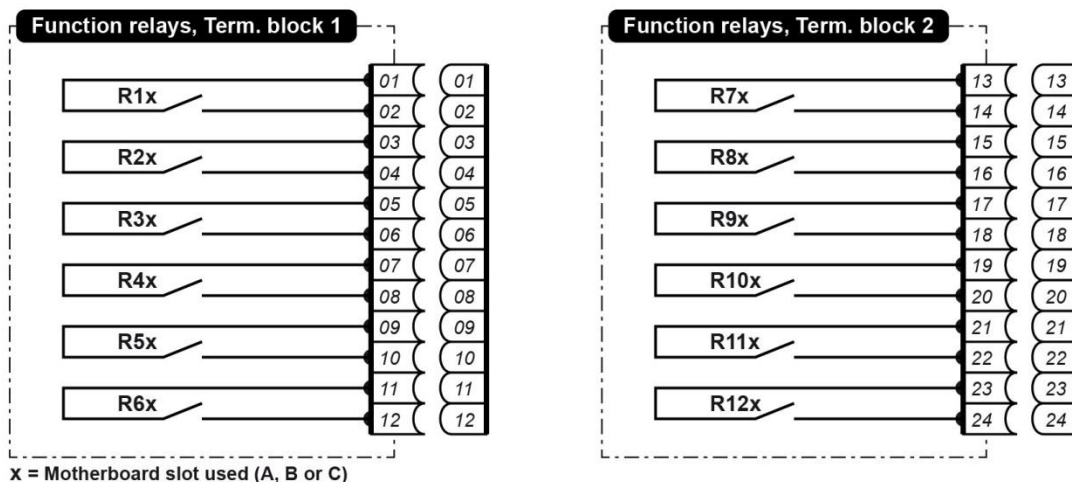

6.2.3 Board with 12 On/Off inputs + 2 analogue inputs

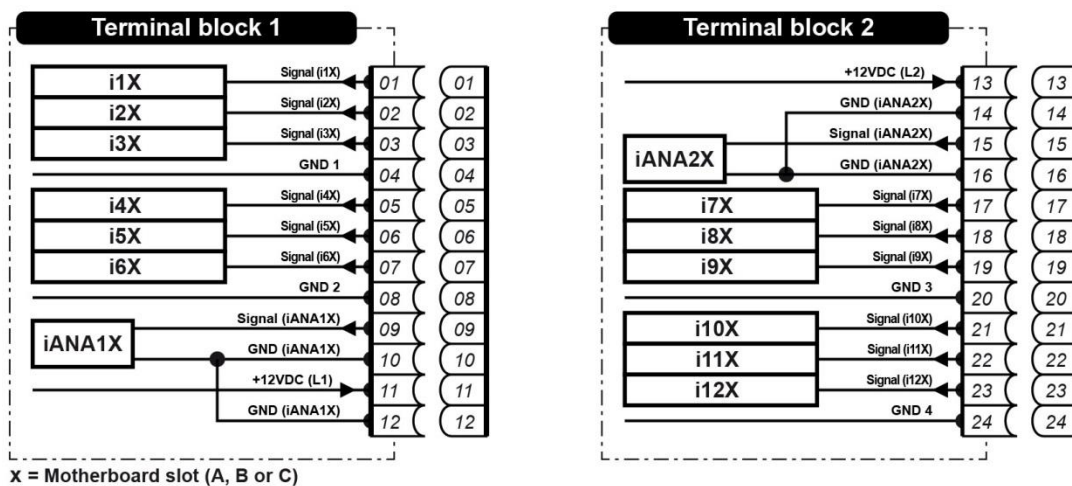

6.2.4 Board with 6 analogue outputs + 1 BYPASS output

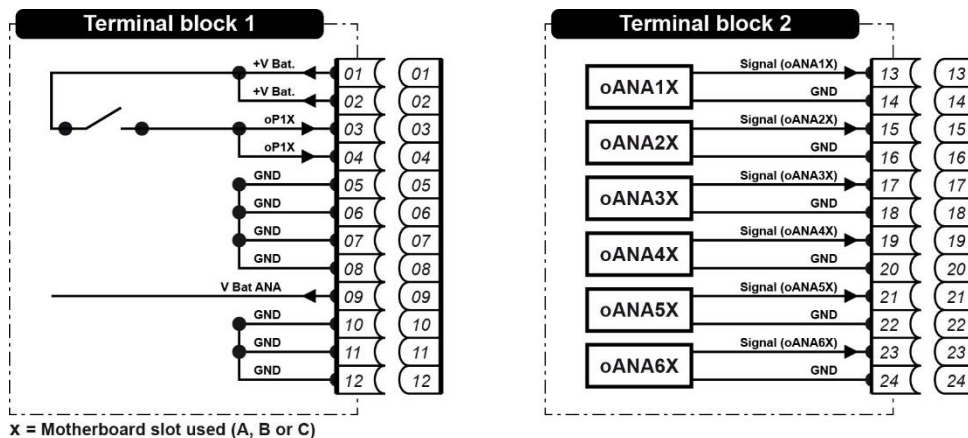

6.3 Transceiver Elio ATEX : internal view

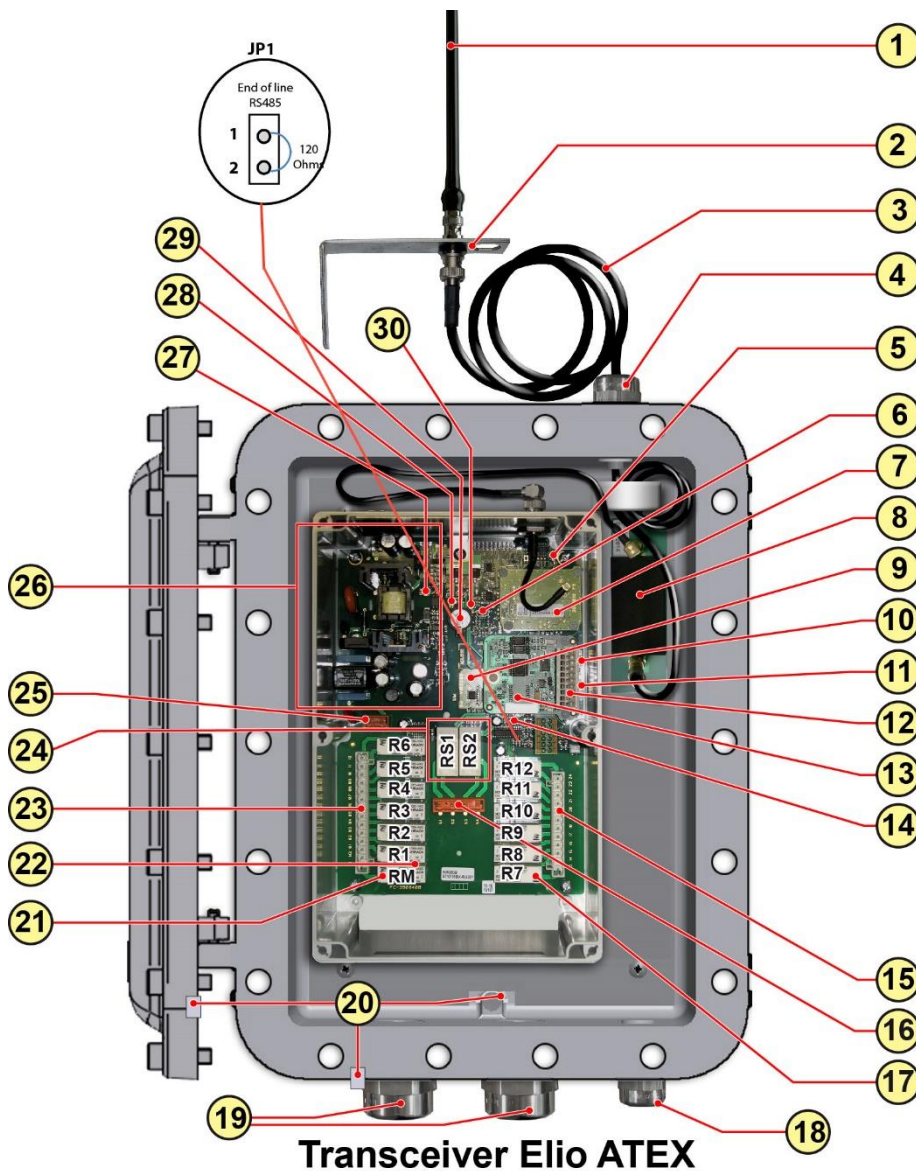

Transceiver Elio ATEX

- ⚡ TO AVOID ANY RISK OF ELECTROCUTION OR EXPLOSION, NEVER OPEN THE TRANSCEIVER UNIT WHEN POWERED UP**
When accessing the interior of the unit, make sure there is no power in the electrical power supply and control cables.
- !** During any intervention requiring the opening of the transceiver housing, you have to take the necessary precautions in order not to degrade the surface state of the 2 jointing planes of the cover seal.
- !** Following any intervention requiring opening of the transceiver housing, be sure to apply a layer of silicon grease (supplied with transceiver) to the jointing plane of the cover seal.
- !** All the transceiver cover screws (18 screws) must be securely in place before the unit is switched ON.

1	Antenna (BNC connection)
2	Mounting bracket with BNC/BNC connector
3	Antenna extension cable (3m)
4	1 x 1/2 " cable gland antenna cable output
5	Red indicator light LD1 : Diagnostics
6	USB connector (configuration and diagnostics)
7	Bidirectional radio module
8	Intrinsic safety barrier for antenna output
9	SIM card (system configuration backup)
10	Green indicator light LD2 : Radio reception + Diagnostics
11	Red indicator light LD3 : Diagnostics
12	Input/output connector of extension board (option)
13	Extension board (analogue outputs, On/Off, RS485 etc.) (option)
14	Red indicator light: status of safety relays RS1 and RS2
15	Connector for relay outputs R7 to R12
16	Connector for safety relay outputs RS1 and RS2
17	Function relays
18	1 x 1/2 " cable gland (option)
19	2 x 1 " cable glands (passageway for control cables / power supply) (which one is optional)

20	3 Earth connection to be connected
21	Function relays
22	Red indicator light : status of function relays
23	Connector for relay outputs RM , R1 to R6
24	Safety relays RS1 and RS2
25	Power supply connector for Elio Transceiver
26	Transceiver power supply circuit
27	Yellow indicator light 12V : motherboard power supply OK
28	Yellow indicator light V2 : processor power supply No. 2 OK
29	Backup battery (daily time stamping of events)
30	Yellow indicator light V1 : processor power supply No. 1 OK

6.3.1 Wiring terminal strips of Elio ATEX Transceiver

Note : The match-up between the Operator module control component commands and the Transceiver relays is given on the configuration sheet supplied with the radio control system.

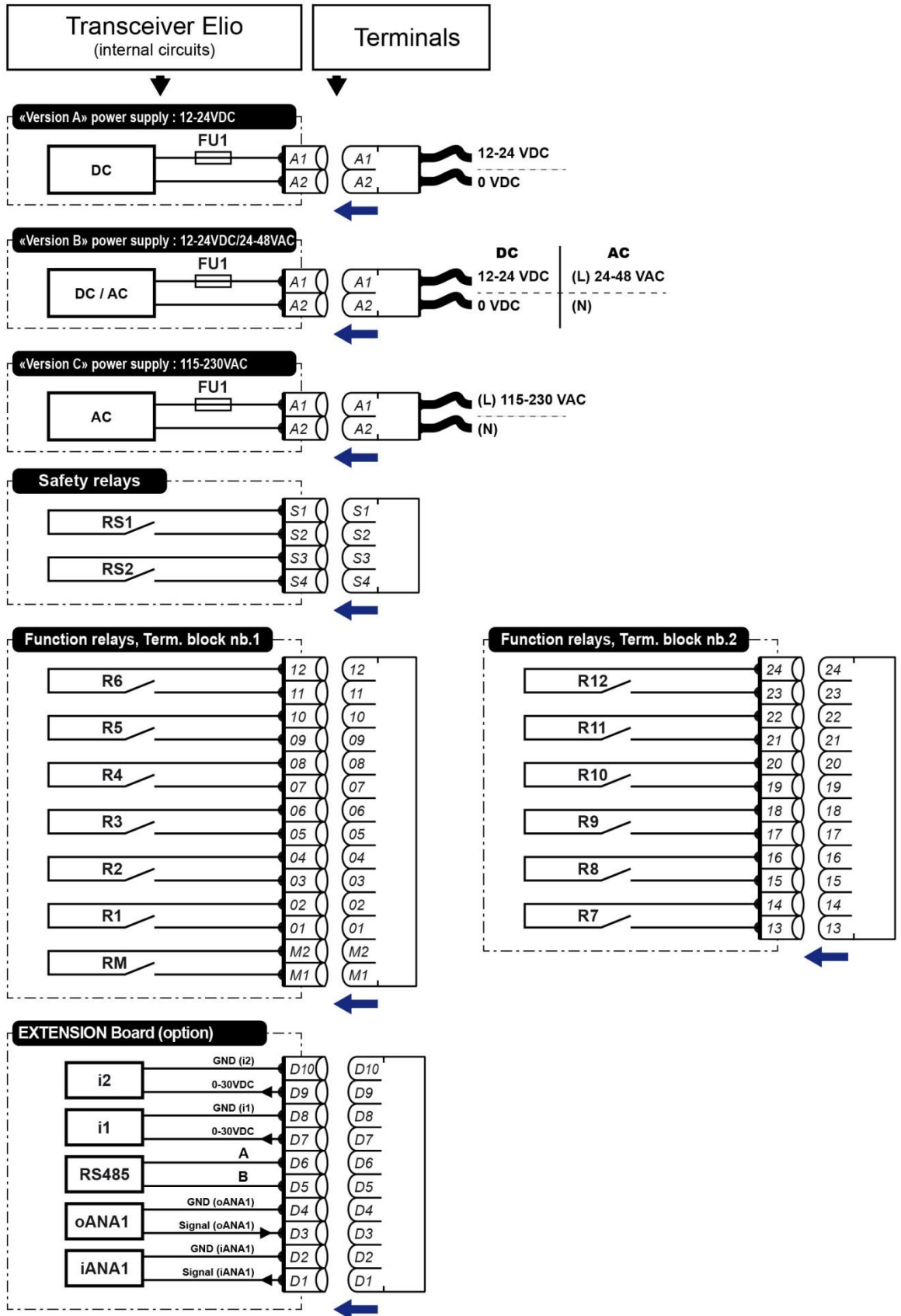

6.4 Connection interface unit PYR ATEX

6.4.1 External view

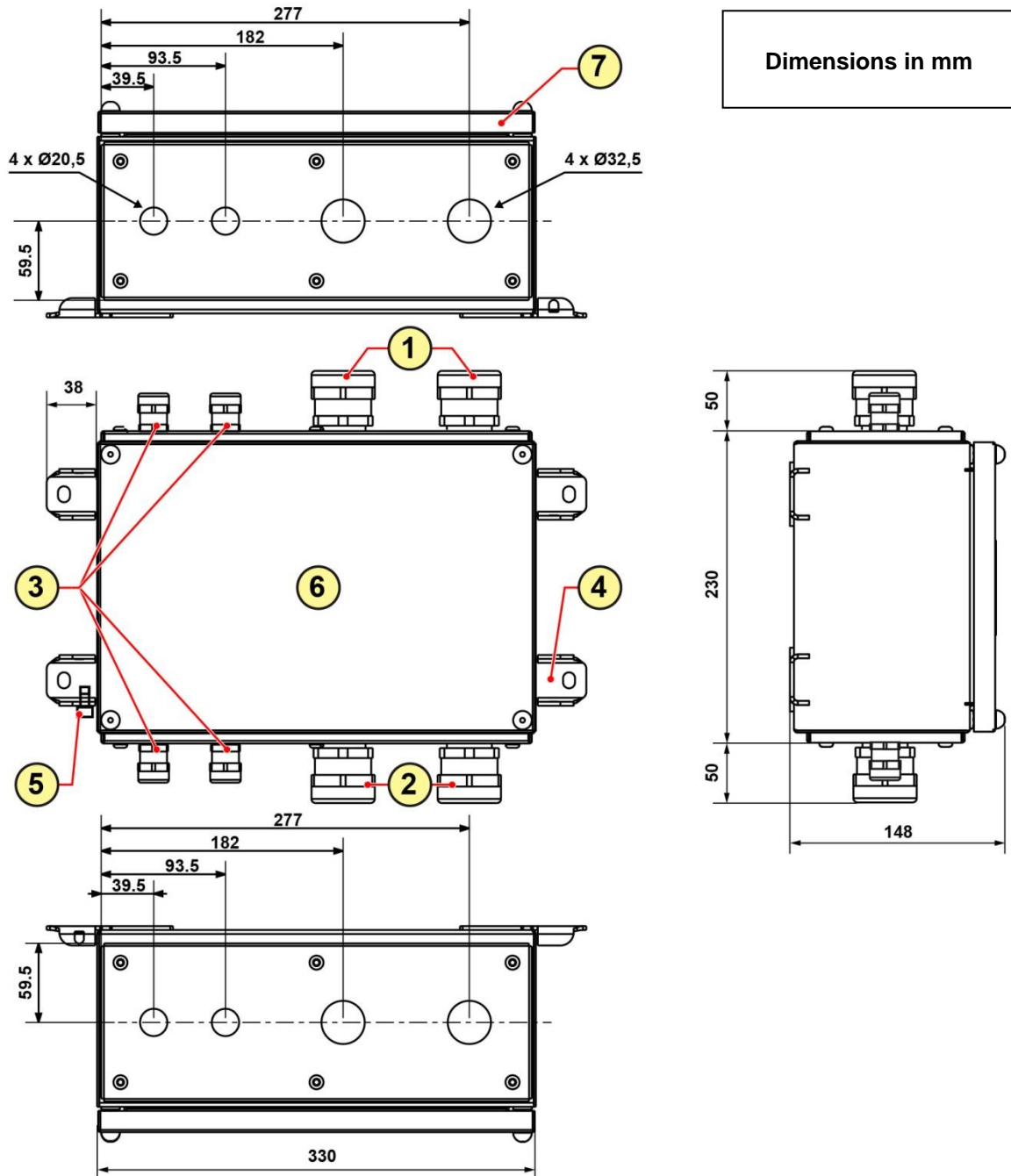

1	2 x M32 cable glands for armoured cable (for passage of power supply / control cables)
2	2 x M32 cable glands for armoured cable (to transceiver ATEX housing)
3	4 x M20 cable glands (for passage of sensor info / control cables)
4	4 mounting lugs
5	Earth connection terminal (green/yellow wire, see chapter « installation / earth wiring »)
6	ATEX Connection interface unit
7	Housing cover

6.4.2 Internal view

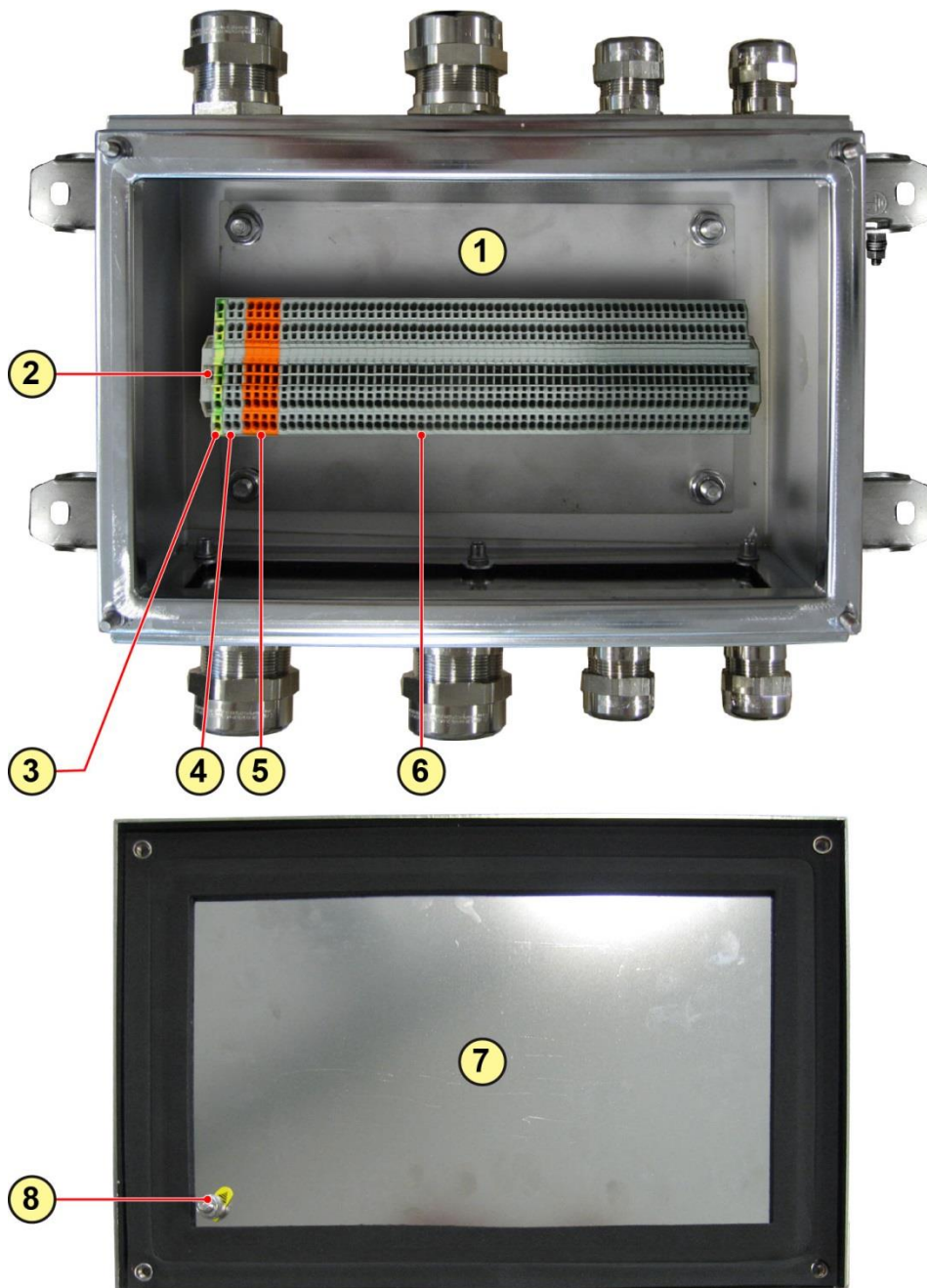

1	ATEX Connection interface unit (open)
2	DIN rail (type 35 x 7,5mm) for mounting of connection terminals
3	1 connection terminal for EARTH (green/yellow wire)
4	2 connection terminals for transceiver power supply
5	4 connection terminals for safety relays RS1 and RS2
6	55 connection terminals for inputs / outputs
7	Housing cover (inside view)
8	Earth connection terminal (green/yellow wire, see chapter « installation / earth wiring »)

6.5 SIM card

A **SIM** card is supplied, installed in the transceiver on a special connector of the management board..

The **SIM** card contains the configuration corresponding to the radio-controlled application. This memory is called the « application memory ».

The radio control system **cannot operate without the « application memory »**.

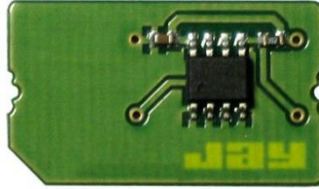

The intervention on the **SIM** card is only accessible with the housings open; this operation must only be performed **OUTSIDE THE ATEX AREA**



TO AVOID ANY RISK OF ELECTROCUTION OR EXPLOSION, NEVER OPEN THE TRANSCEIVER UNIT WHEN POWERED UP
When accessing the interior of the unit, make sure there is no power in the electrical power supply and control cables.



During any intervention requiring the opening of the transceiver Ex-Proof housing, you have to take the necessary precautions in order not to degrade the surface state of the 2 jointing planes of the cover seal.



Before closing the ex-proof housing : put in place the cover and close the inner plastic housing (6 screws)



Following any intervention requiring opening of the transceiver Ex-Proof housing, be sure to apply a layer of silicon grease (supplied with transceiver) to the jointing plane of the cover seal.



All the transceiver cover screws of ex-proof housing (18 screws) must be securely in place before the unit is switched ON.

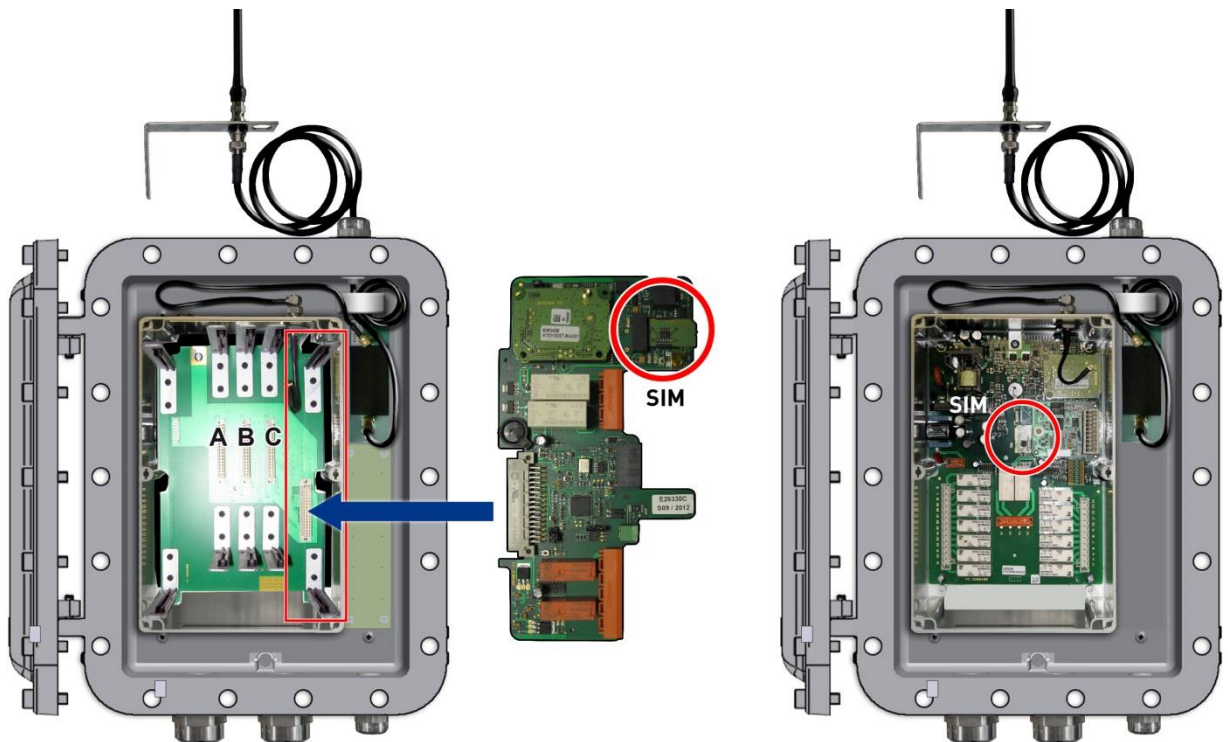

Transceiver Alto ATEX

Transceiver Elio ATEX

6.6 USB connection

Using the USB connection is possible only when the transceiver is powered off.

 The **USB** connection is only accessible with the housings open; this operation must only be performed **OUTSIDE THE ATEX AREA**

 **TO AVOID ANY RISK OF ELECTROCUTION OR EXPLOSION, NEVER OPEN THE TRANSCEIVER UNIT WHEN POWERED UP**
When accessing the interior of the unit, make sure there is no power in the electrical power supply and control cables.

 During any intervention requiring the opening of the transceiver Ex-Proof housing, you have to take the necessary precautions in order not to degrade the surface state of the 2 jointing planes of the cover seal.

 Before closing the ex-proof housing : put in place the cover and close the inner plastic housing (6 screws)

 Following any intervention requiring opening of the transceiver Ex-Proof housing, be sure to apply a layer of silicon grease (supplied with transceiver) to the jointing plane of the cover seal.

 All the transceiver cover screws of ex-proof housing (18 screws) must be securely in place before the unit is switched ON.

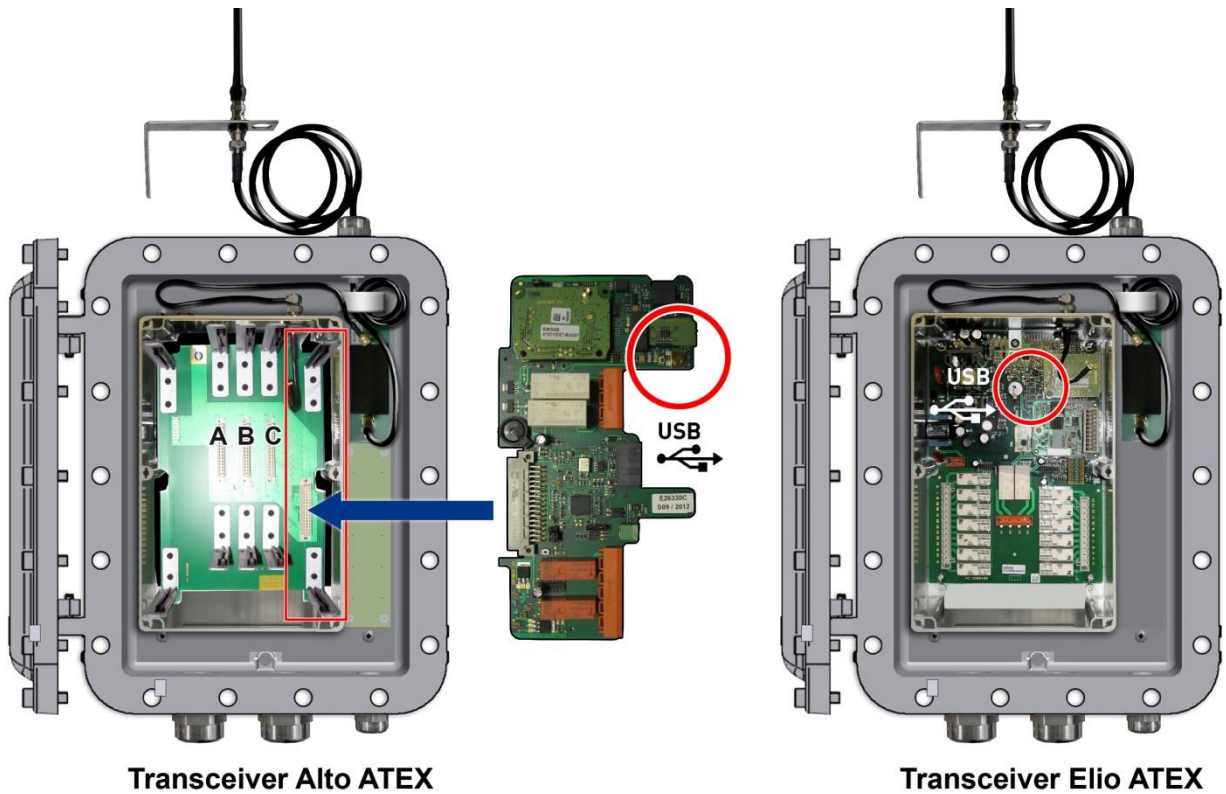

6.7 Transceiver indicator light functions and messages



IMPORTANT :
The visual indicators are only accessible with the housings open; the indicators must only be read **OUTSIDE THE ATEX AREA**



During any intervention requiring the opening of the transceiver Ex-Proof housing, you have to take the necessary precautions in order not to degrade the surface state of the 2 jointing planes of the cover seal.



Before closing the ex-proof housing : put in place the cover and close the inner plastic housing (6 screws)



Following any intervention requiring opening of the transceiver Ex-Proof housing, be sure to apply a layer of silicon grease (supplied with transceiver) to the jointing plane of the cover seal.



All the transceiver cover screws of ex-proof housing (18 screws) must be securely in place before the unit is switched ON.

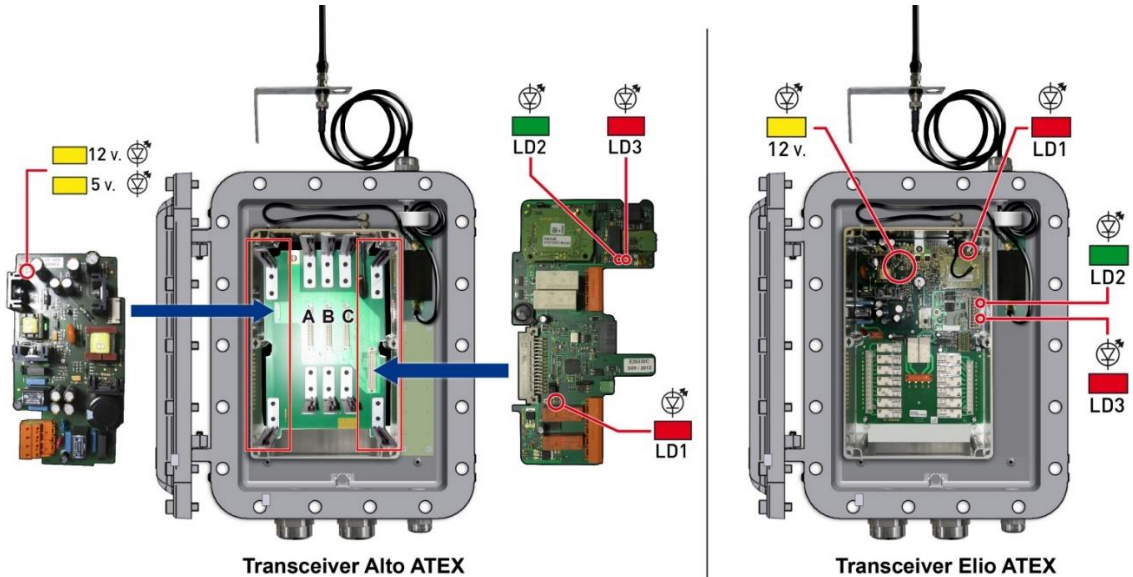

Safe Mode = The Receiver is energized, and standby for a « Start » order

Operating mode = The Receiver is started, its safety relays **RS1** and **RS2** are activated and their contacts are closed

Messages in nominal operating condition:

Mode	LD1 (red)	LD3 (red)	LD2 (green)	12V - power. V+ power. (yellow)	Description
Safe	OFF	OFF	OFF	ON	Nominal operating state
Safe	OFF	OFF	Flashing	ON	The Receiver is in "Association" mode
Safe	Flashing with pauses for a second	OFF	Flashing with pauses for a second	ON	The Receiver is in configuration mode with the Transmitter
Operating	OFF	OFF	ON and OFF for a short period (once per second)	ON	Nominal operating state

Messages in case of errors or operating problems:

Mode	LD1 (red)	LD3 (red)	LD2 (green)	Power (yellow)	Description
When powering up	OFF				Power problem, check fuse(s) or power cables
Under voltage	ON		OFF	ON	Hardware or software defect that prevents starting. Read the logbook and contact the after-sales service.
Under voltage	Flashing lights 2 flashes		OFF	ON	SIM or EEprom fault. Check and/or reload the parameterization sheet.
Under voltage	OFF	8 fast flashes	OFF	ON	Additional card defect. Check unexpected presence/absence, positioning error...
Under voltage	OFF	8 slow flash	OFF	ON	Default time internal clock. Check time (iDialog), check battery.
Under voltage	Cycle LD1 LD3 ON and LD2 OFF / LD1 LD3 OFF and LD2 ON			ON	Synchronization in progress. Wait for restart.
Under voltage	OFF		1 Flash	ON	Indicator for the reception of a radio frame.
Under voltage	OFF		3 Flashes	ON	Indicator for the reception of a radio frame with an unrecognized identity code

7 Options and special functions

7.1 "Master – Master synchronised command" function

This function enables one to control two items of equipment in a synchronised manner. The movements made by the items of equipment will be from a single transmitter.

A solution produced with this function comprises:

- **2 transmitters** (Either Beta/Gamma or Pika/Moka type, it is not possible to mix Transmitters with buttons and Joysticks in DUO mode)
- **2 Receivers**

Note 1: It is possible with this function to have « *live signal* » transmitted by radio between the two Receivers to secure the two Receivers, in case of security of one or the other receivers following a passive stop. In case of failure, both MT will stop in 2069ms max. The time between the first MT stop and the second MT stop will not exceed 1169ms.



The life signal can only be set by IDialog. Please check the IDialog user manual to know how to use the life signal.

Note 2: This function is not accessible when the receiver is configured with a cable link.

7.1.1 Operating principle

The products may operate together in **3 different ways**. An operating mode is selected **when the transmitters start up**:

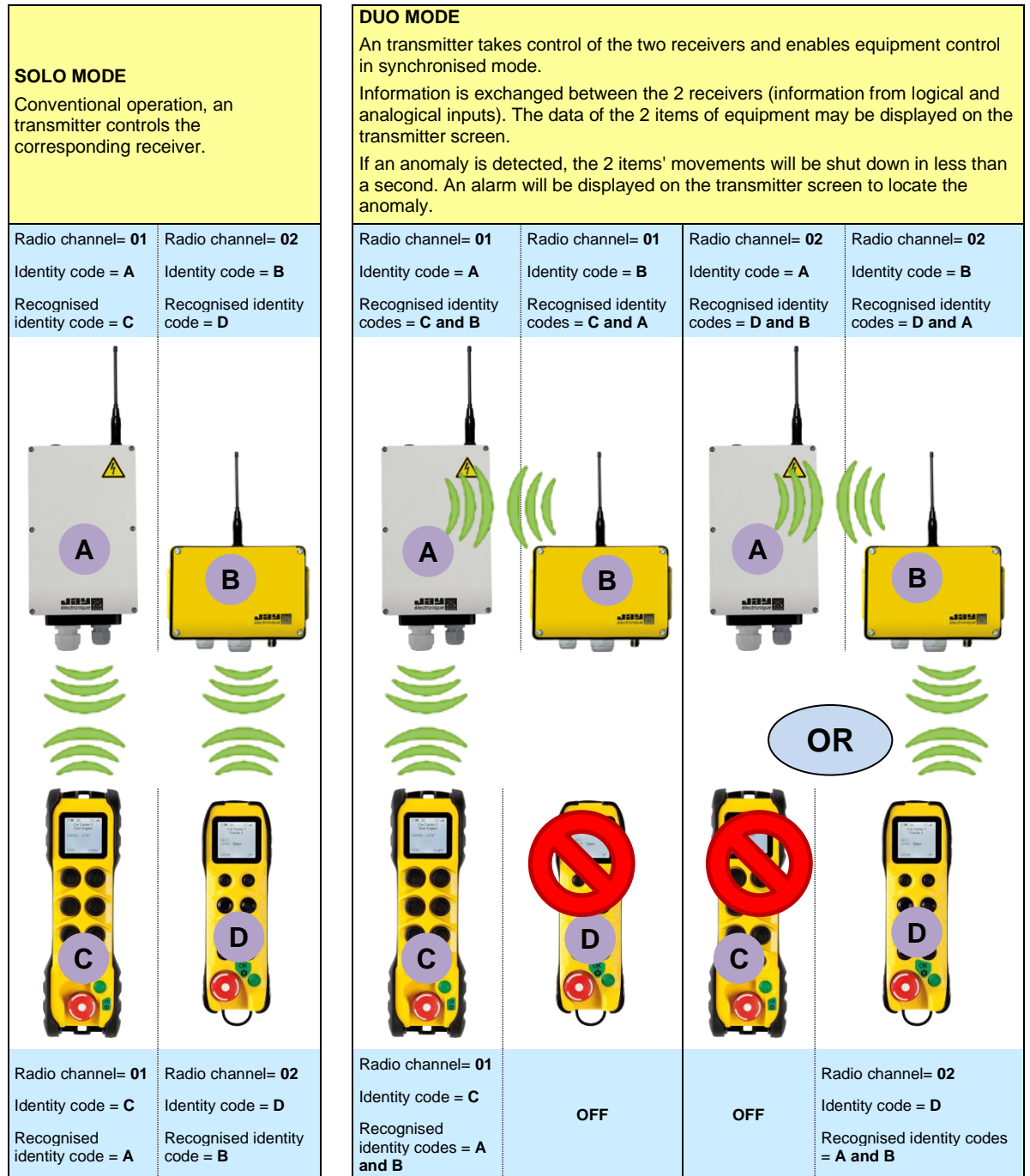

In the coupled DUO mode (A + B), the 2 Receivers can exchange the status of limit switches and sensors (up to 16 on-off information and 1 analog information) as well as the status of their safety relays.

7.1.2 Use

Examples of possible ways of starting transmitters:

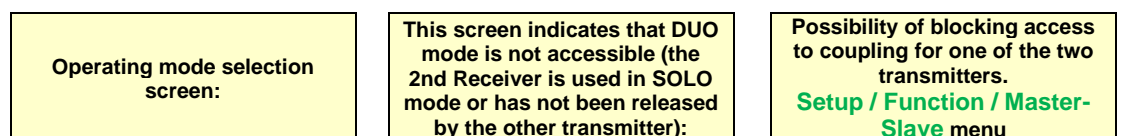



If one of the two receivers is unavailable (already used by another transmitter), the following message will appear:

No transceiver

During use: Examples of information feedback on the transmitter screen

Indication of load raised for CRANE 3T and CRANE 5T on the transmitter in DUO mode

Indication of a message or an alarm (from an end of line contact, activated TOR input, sensor value, etc.)*

* = can be changed with the programming software **iDialog**

7.1.3 Change to operating mode and system shutdown

A mode change selection (**DUO** or **SOLO**) can be made each time the products start up.

Release of a Receiver when the system is shut down:

A receiver can be released automatically after a shutdown or by a voluntarily order. The choice of a voluntary release can be set using the **iDialog** programming software.

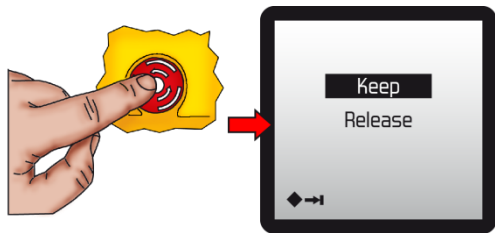

7.1.4 Procedure for associating Transmitters / Receivers

Products with the "**synchronised command**" function are delivered already configured and associated.

However, it may be necessary to create an association again, if a product is replaced for example.

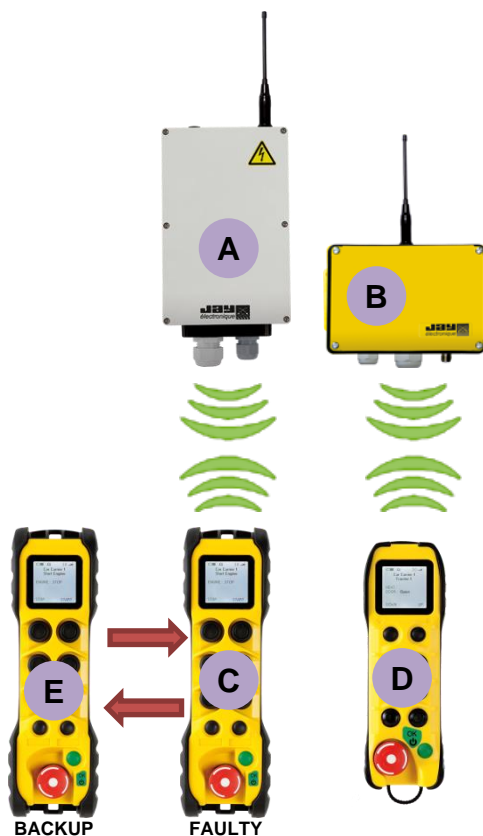

1. Follow the procedure for association between the Transmitter **E** and the Receiver **A** described in the chapter **3.5 "Learning" function**

For each of the transmitters, go to the menu: **Setup / Radio / Master-Slave / Settings**

2. Configure the backup Transmitter **E** by copying the identity code and radio channel information used by the Transmitter **D** and the Receiver **B** id code.
3. Confirm by pressing the green "validate" pushbutton.
4. Configure the Transmitter **D** by copying the identity code and radio channel information used by the backup Transmitter **E** and the Receiver **A** id code.
5. Confirm by pressing the green "validate" pushbutton.

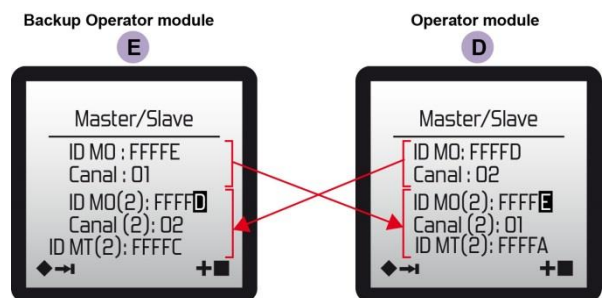

6. Press the safety stop palmswitch on the 2 transmitters.
7. Wait for twenty seconds before starting the transmitter(s)

The association procedure is complete.

7.1.5 Procedure to change radio channel

Prerequisites:

Unless the "Transmitters and Receivers" assembly is configured in **automatic release** mode, both receivers must be released.

To do so, the receivers must be on, press the "Master" Transmitter stop palmswitch and validate the choice "Release" by pressing the green "validate" pushbutton.

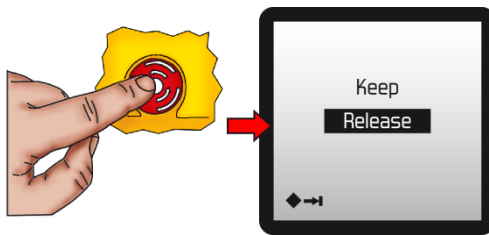

Example changing a radio channel on one of the two transmitters:

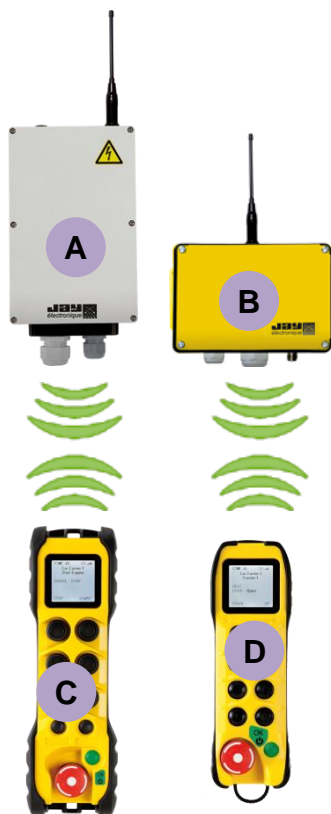

1. On the 2 transmitters, access the **Setup / Radio / Master/Slave / Settings** menu
2. On transmitter **C**, change the **Active Channel**
3. Confirm by pressing the green "validate" pushbutton.
4. On transmitter **D**, change the **Channel (2)**
5. Confirm by pressing the green "validate" pushbutton.

E.g. changing the radio channel on the transmitter C, radio channel no. 34 instead of no.22:

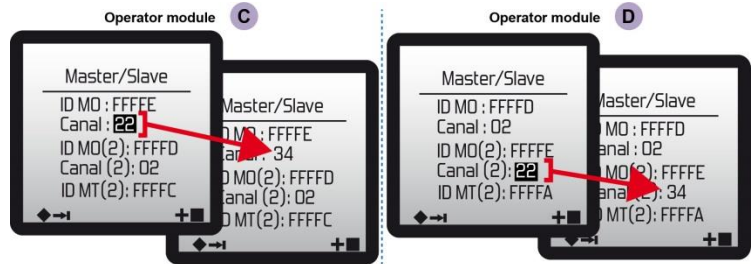

6. Press the safety stop palmswitch on the 2 transmitters.
7. Wait for twenty seconds before starting the transmitter(s)

The radio frequency changing procedure is complete.

7.1.6 Compatibility with "Start up by infrared validation" option

This option is compatible with the "Master-Master synchronised command" function.

To start the system, both in **SOLO** mode and in **DUO** mode, the transmitter must be pointing towards the IR cell on the associated Receiver:

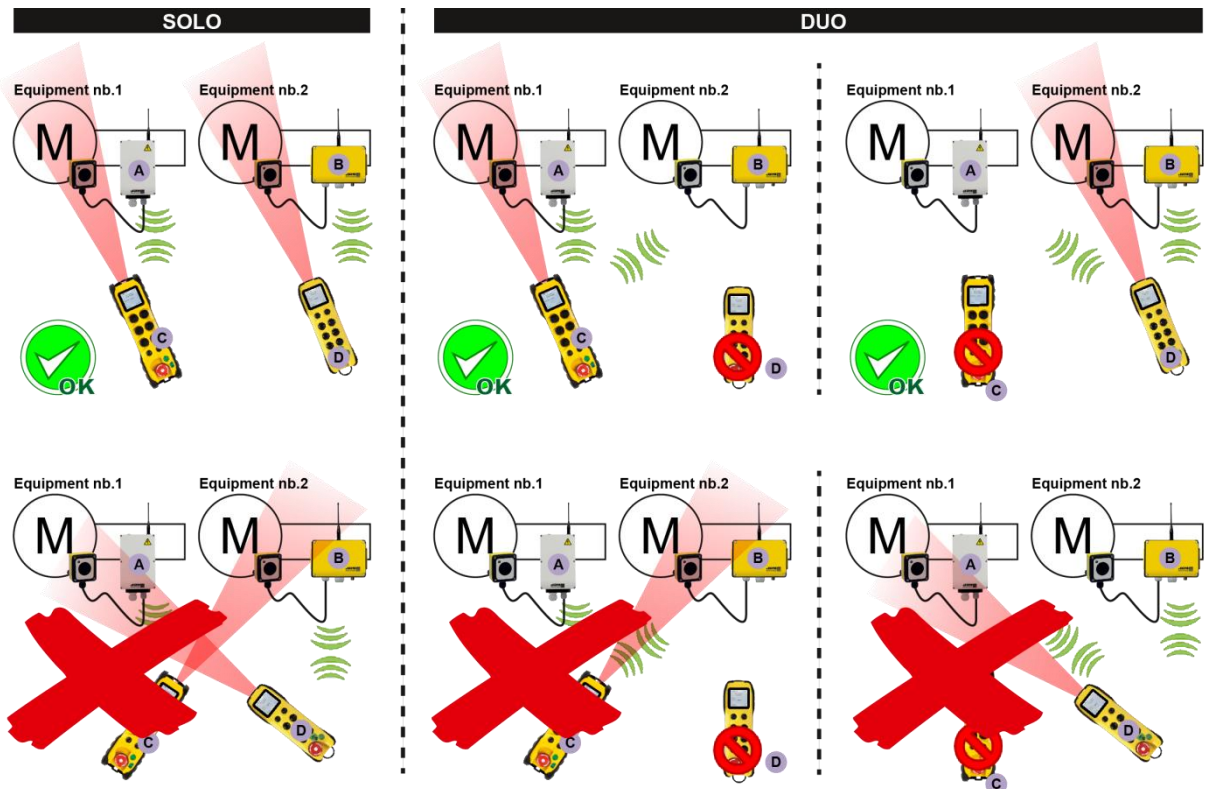

7.2 "Tandem synchronised command" function

This function allows to control two equipments with a single Transmitter. The control of the two Receivers can be synchronized or not.

A product solution with this function is composed of:

- 1 Transmitter (specially configured for the "synchronized control" function)
- 2 Receivers

Note 1: It is possible with this function to have a « *live signal* » transmitted by radio between the two Receivers to secure the two Receivers, in case of security of one or the other receivers following a passive stop. In case of failure, both MT will stop in 2069ms max. The time between the first MT stop and the second MT stop will not exceed 1169ms.



The life signal can only be set by IDialog. Please check the IDialog user manual to know how to use the life signal.

Note 2: This function is not accessible when the receiver is configured with a cable link

7.2.1 Operating principle

The products can work in different ways:

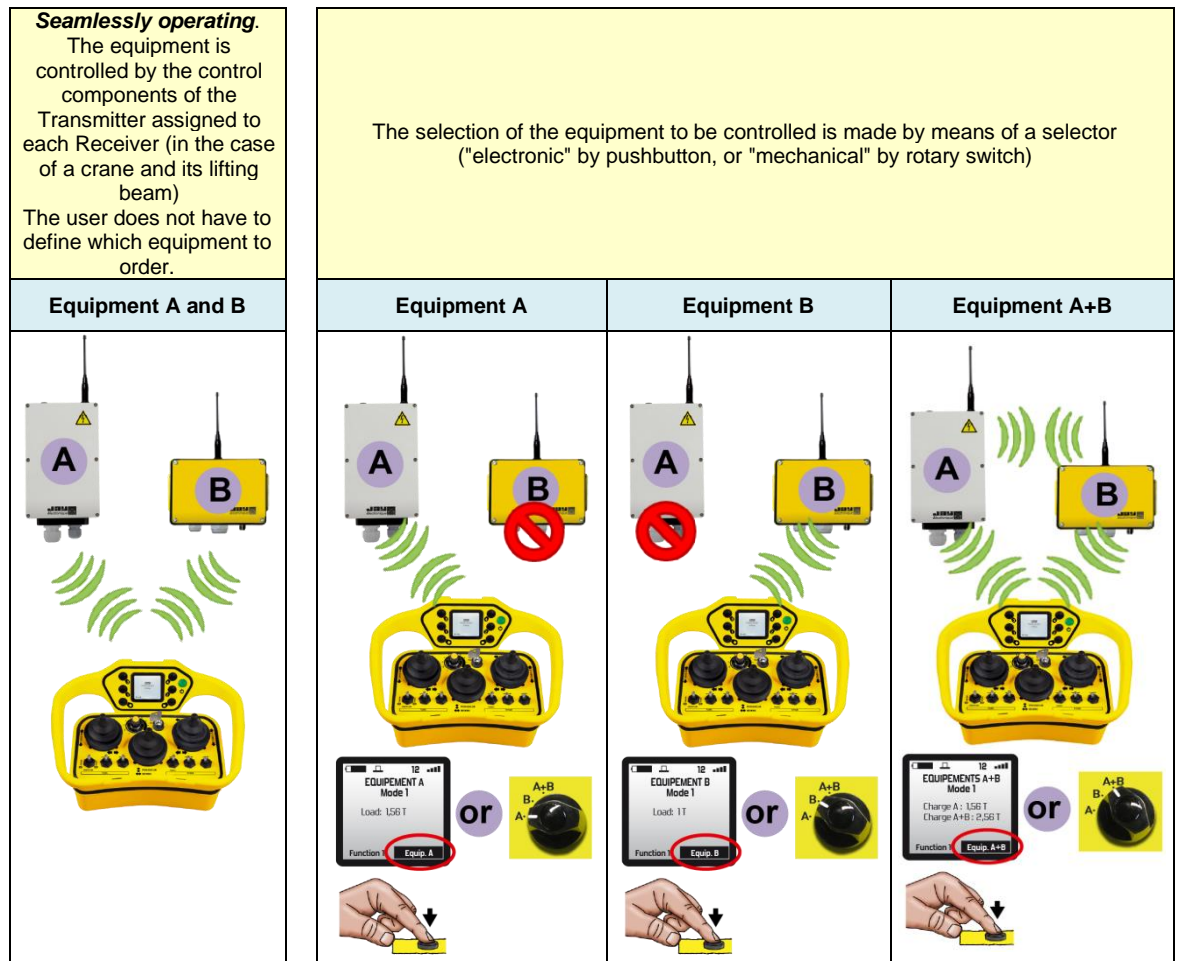

In the coupled DUO mode (**A + B**), the 2 Receivers can exchange the status of limit switches and sensors (up to 16 on-off information and 1 analog information) as well as the status of their safety relays.

Note: If one of the two receivers does not respond in the start phase, only the receiver that responded to the start request will be active.

7.2.2 Use

During use: Examples of information feedback on the transmitter screen (2 travelling cranes: 3T and 5T):

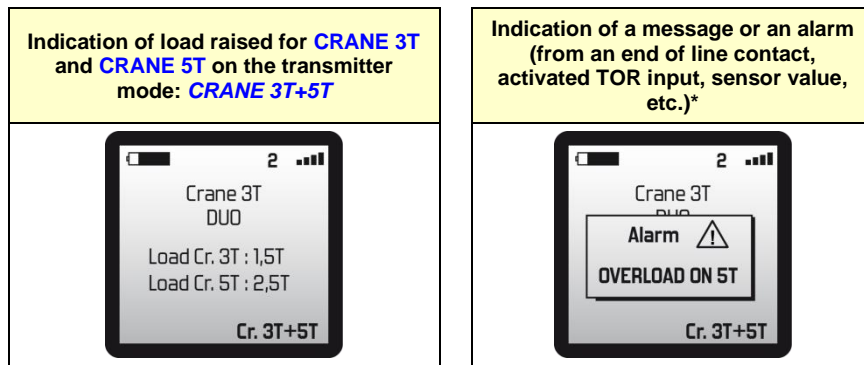





* = can be changed with the programming software **iDialog**



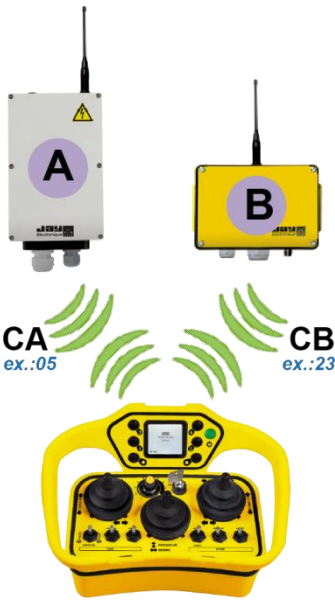
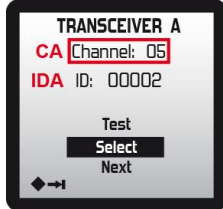

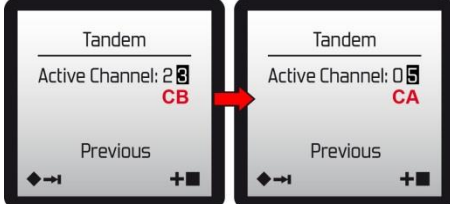

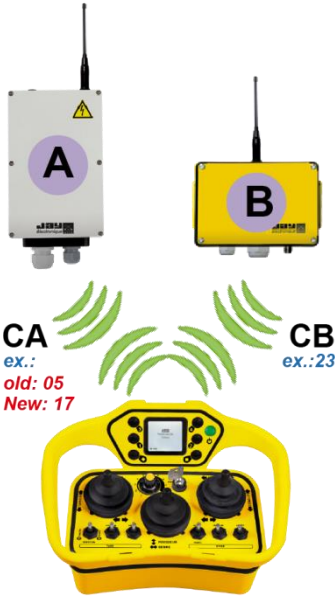

7.2.3 System Shutdown

After pressing the stop button on the Transmitter, the Receivers are automatically "released". The system can be started again.

7.2.4 Associating the Transmitter with Receivers

	<p>1. Associate the Transmitter with Receiver A, note the working radio channel CA and the IDA code (see chapter 3.5 "Learning function")</p>	
	<p>2. Associate the Transmitter with Receiver B, note the working radio channel CB and the IDB code. (see chapter 3.5 "Learning function")</p>	
	<p>3. Indicate the working radio channel CA and the IDA code to Receiver B Go to the menu: Setup / Radio / Tandem / Settings</p>	
	<p>4. Then, select the radio channel used to communicate to Receiver A to finalize the association Go to the menu: Setup / Radio / Tandem / Selection</p>	
	<p>5. Indicate the working radio channel CB and the IDB code to Receiver A Aller dans le menu: Go to the menu: Setup / Radio / Tandem / Settings</p>	
	<p>6. Press the safety stop palmswitch on the transmitter</p>	<p>7. Wait for twenty seconds before starting the transmitter</p>
	<p style="text-align: center;">The association procedure is completed</p>	

7.2.5 Changing the radio channel on a Receiver

 <p>CA ex.: old: 05 New: 17</p> <p>CB ex.: 23</p>	<p>1. If not already done, select the radio channel you wish to add. right here Receiver A Go to the menu: Setup / Radio / Tandem / Selection</p>	
	<p>2. Modify the active working channel with Receiver A in the menu Setup / Radio / Tandem / Settings</p>	 
	<p>3. Then select the radio channel used to communicate with the Receiver B Go to the menu: Setup / Radio / Tandem / Selection</p>	 
	<p>4. Enter the new radio channel CA at Receiver B Go to the menu: Setup / Radio / Tandem / Settings</p>	 
	<p>5. Press the safety stop palmswitch on the transmitter</p>	
	<p>6. Wait for twenty seconds before starting the transmitter</p>	
<p>The radio channel change procedure on Receiver A is completed</p>		

7.3 « Pitch & catch 2.0» function

This function allows to manage:

- Alternately from **2 up to 20 Transmitters** (20 Operators)*
- with **1 Receiver** (1 equipment).

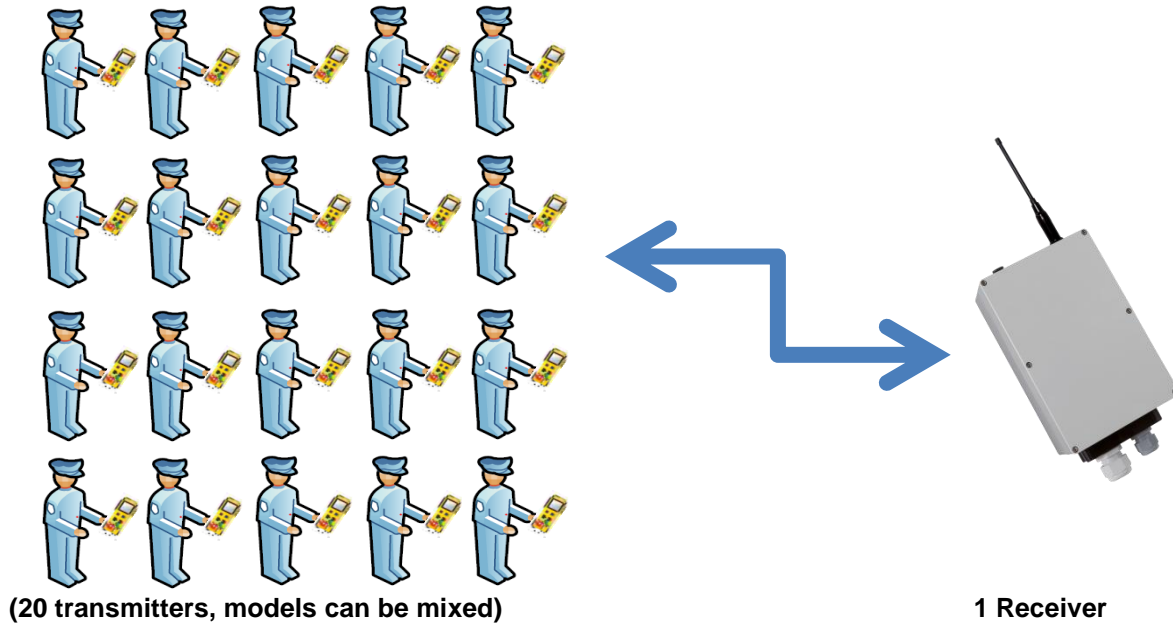

Note 1: The functions (start by IR enable, Multimodes 3 to 32 ...) are compatible with the Pitch & Catch 2.0 function

*= The number of Transmitters can be set with the **iDialog** software, see the following chapter « [Configuration](#) »

7.3.1 Operating principle

The Receiver is radio-controlled by one Transmitter at a time.

When an equipment is controlled by an operator, the other operators must wait for the **release** (availability) of the equipment to take control.

All the Transmitters operate on the same radio.

7.3.2 Use

The use of the Receiver can only be done with **one Transmitter at a time**.

The Receiver is starting by the normal way. However, if the Receiver is already used by an Transmitter or has not been "**Released**" at the end of a previous use, the following message appears on the Transmitter screen:

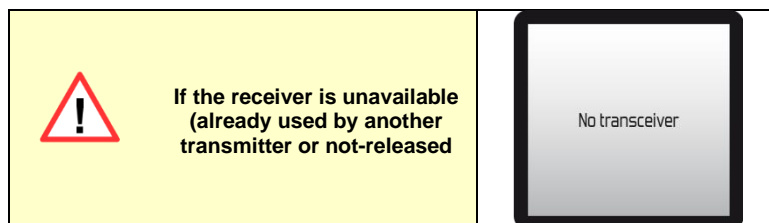

7.3.3 System shutdown (and release)

After pressing the stop button on the Transmitter, the Receiver can be released either **automatically*** or **manually***:

"Automatic release": As a general rule, the equipment is released as soon as the radio connection is interrupted. Another transmitter can then immediately start the Receiver.

"Manual release": For applications where safety has to be reinforced, the equipment can be released by a voluntary action of the operator (eg combination of buttons etc ...). Another transmitter will not be able to start the Receiver until it has been "released".

* = The « release mode » is configurable with **iDialog** programming software

7.3.4 Configuration

The configuration of the Pitch and Catch function is performed using the **iDialog** software, menu **Use parameter / Synchronized control**



Release Mode: Automatic or Manual

Maximum number of Transmitter: Enter the number of Transmitters that will drive the Receiver sequentially (max 20).

The information associated with this operating mode is displayed by a logo in **Setup / Radio** menu.



7.3.5 Associating an Transmitter with the Receiver

The procedure for associating the Transmitters is the same as for a standard association.

Each Transmitter must be associated one by one with the Receiver (see section **3.5 «Association» function (association with a Receiver)**)

7.3.6 Changing the radio channel

Take one of the Transmitters and apply the radio channel change procedure of a standard solution.

For the other Transmitters already associated with the Receiver, make a start and wait until they find the new radio channel.

7.3.7 Replacing an Transmitter (backup model)

Same procedure as with standard solution (Transmitter / Standard Receiver association procedure).

Note: The new Transmitter will take the place of the one whose use is the oldest.
In case of doubt, start by starting alternately all the transmitters to keep.

7.3.8 Replacing the Receiver

Same procedure as with standard solution.

The Transmitter / Receiver combination must be performed for each Transmitter.

7.4 “Pick & Control 2.0” function

Introduction

This function enables the user to select 1 receiver module from a maximum of 32.

Note 1: all transmitters and receivers must have the same configuration sheet and be equipped with exactly the same material (configured in digital input)

Note 2: in “digital input” configuration, the On/Off input 1 on the equipment is always reserved for this function. See chapter entitled “*Erreur ! Source du renvoi introuvable.*”. Description of all digital input on each product in chapter §10.3 ATEX Transceiver Alto and Elio.



The ELIO receiver must be equipped with the expansion card.

Note 3: if used with several transmitters, the operating channel must be different on each transmitter. This initialisation must be carried out before beginning to operate the equipment during initial commissioning.

7.4.1 Association in “Pick & Control 2.0”

The Association in “Pick & control 2.0” is performed like described in the chapter §3.5



If the product is configured in “digital input”, Only the MT with the ON/Off input 1 set to “high” will respond on the “Rest channel”.



To avoid that a user can performed an association. The association can be protected by a pin code. The pin code is configured by **iDialog**

7.4.2 Operation

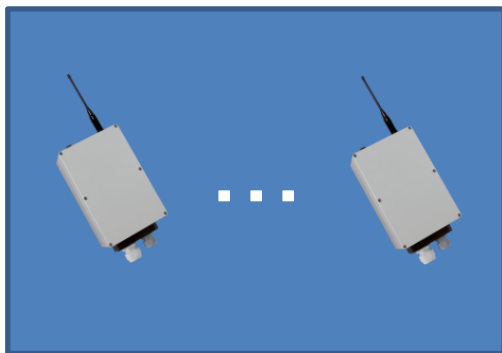

(1 to 32 receiver modules)



x transmitters

Once the list of receiver modules has been created, the “Pick & Control 2.0” function allows each receiver module on the list to be used without the need for programming.

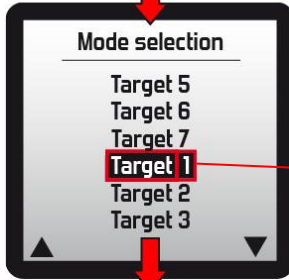
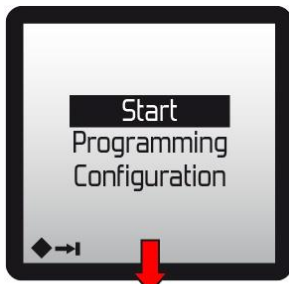

“Target” corresponds to the name of the operating mode.

“1” corresponds to the operating mode number. An operating mode corresponds to a receiver module.

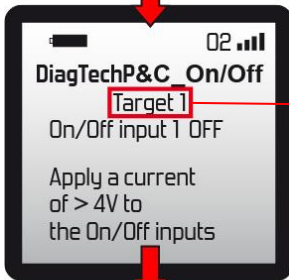

Target 1 has been selected in the list.

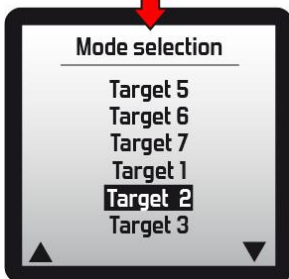

The list can be displayed using the navigation button defined in **iDialog** in order to use a different receiver module. Displaying the menu stops operation of the current receiver. The max. number of receiver modules available in the list is defined in **iDialog**.

Note 1: only one receiver module can be managed at any one time by the same transmitter.

If the target selected is unavailable (absent or already used by another transmitter), the following message is displayed:



7.4.3 Stop operation:

Transmitter:

The operator triggers the emergency stop.
The transmitter emits a radio frame requesting the stoppage.

OR

The operator displays the list of registered receiver modules.
The transmitter emits a radio frame requesting the stoppage.
A new receiver module can be selected from the list.

Receiver module:

When the receiver module exists “operating” mode for “safety” mode, it switches radio channel (operating > rest) and is available in the group of receiver modules at rest.

Stop operation MT x

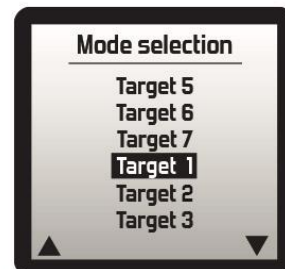
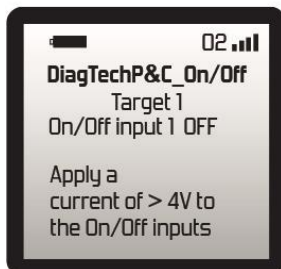

7.4.4 Creating and modifying the list



To avoid that a user can change the list. The configuration menu can be protected by a pin code. The pin code is configured by *iDialog*

The list contains the identities of the receiver modules that can be operated by the transmitter. The “List” menu allows a receiver to be added/deleted to/from the list or to be replaced by another receiver.

To access the “List” menu, complete the following steps:

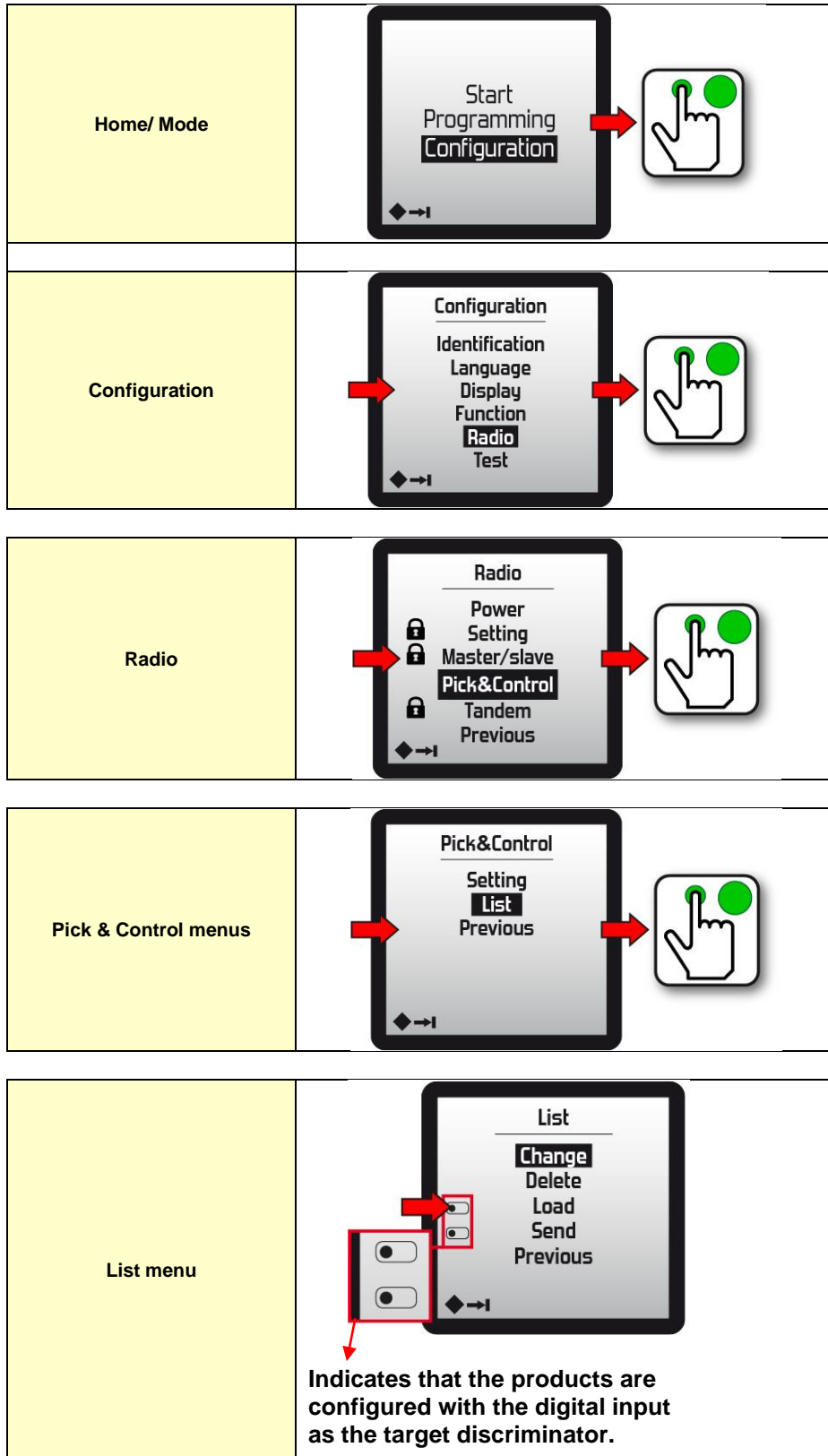

7.4.4.1

“Change” menu

The “Change” menu allows a receiver module to be added to, changed or deleted from the list.

Adding a new receiver module:

Here, the product is configured for digital input. To add a new receiver module, activate the On/Off input 1 on the receiver module that is to be added to the list (the target) and press the green validation button to save its identity.

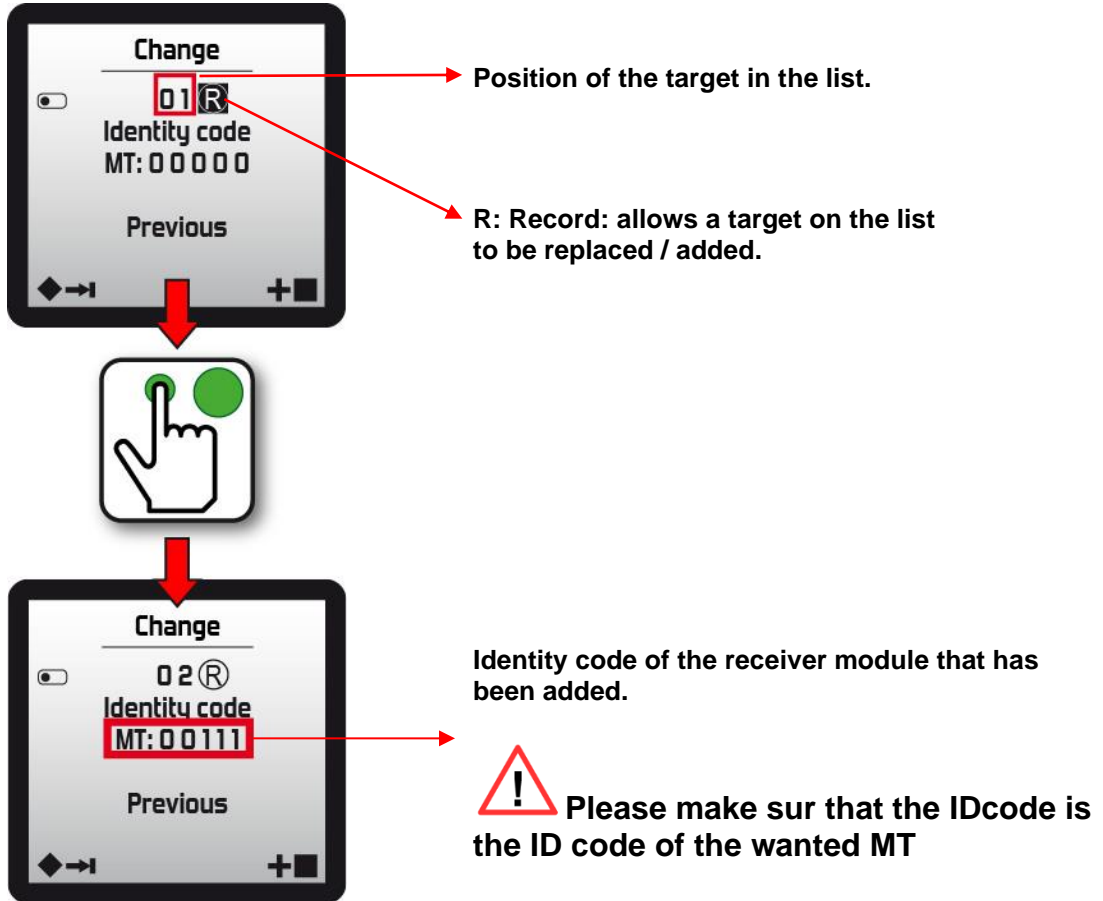

Activating an alarm:

During use, a warning message may be displayed. This means that the element could not be saved (the receiver module did not answer (switched off) or the transmitter did not receive a response (radio interference)).

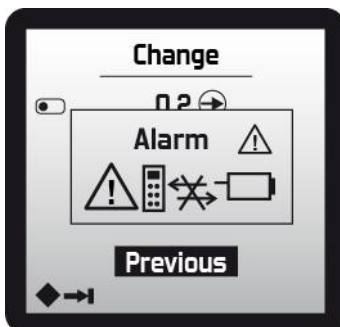

Remark 1: all warning messages can be deleted by pressing the “On” button  on the transmitter.

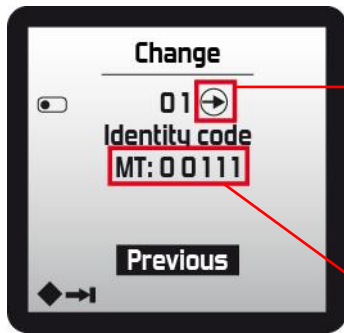

Allows the user to navigate within the list by pressing the green button. The right arrow → allows the user to move in ascending order while the left arrow ← can be used to move in descending order. The selection can be changed using the navigation button.

Identity code of the receiver module in position 1 on the list.



Please make sur that the IDcode is the ID code of the wanted MT

The different options of the “Change” menu

R = Record: allows a target on the list to be replaced.		<p>Change 01 Identity code MT: 0 0 1 1 1</p>	
Bin: allows a receiver module to be deleted.		<p>Change 01 Identity code MT: 0 0 1 1 1</p>	
Right arrow: allows the user to change selection in ascending order		<p>Change 01 Identity code MT: 0 0 1 1 1</p>	
Left arrow: allows the user to change selection in descending order		<p>Change 01 Identity code MT: 0 0 1 1 1</p>	



When the “list” is completed, please check the list of MT and the position in the list to make sur that the installation is good. To check the list, please check chapter \$3.8.3.3 Tables

7.4.4.2

“Delete” menu



This allows the list contained in the transmitter to be deleted.



7.4.4.3

“Load” menu



This allows a list contained in a receiver module to be imported to the transmitter.

The receiver module selected must have the On/Off input 1 activated or be targeted by the infra-red if it is configured to infra-red.



7.4.4.4 “Send” menu



This allows the list contained in the transmitter to be exported to a receiver module. The receiver module selected must have the On/Off input 1 activated or be targeted by the infra-red if it is configured to infra-red.



7.4.5 Rest channel and operating channel

The rest channel is determined by the configuration sheet and cannot be modified by the transmitter.

The rest channel is the channel on which all the receiver modules are in listening mode.

The operating channel (active channel) must be different from the rest channel and can be changed by the transmitter.

The operating channel is the channel on which the transmitter manages the sole receiver module in use.

If several transmitters are used at the same time within the group, the associated operating channels must be different.



Rest channel: all receiver modules in the group are in listening mode on this channel until start of operation.

Operating channel: this channel must be different on each transmitter. It is the channel used for operating purposes.



If there is multiple system (different park of MTs) configured in “Pick and control 2.0” make sure that the “rest channel” is different from the other park of MT. The “Rest channel” can be configured by iDialog.

7.4.6 Transferring a list from transmitter to transmitter

The lists can easily be transferred from one transmitter to another using the “Send” and “Load” functions.

To transfer a list from one transmitter to another transmitter, the following steps must be completed:

- Start the transmitter containing the list that is to be transferred
- Send the list to a reference receiver module using the “Send” function
- Start the transmitter that is to retrieve the list
- Retrieve the list contained in the receiver module using the “Load” function
- The two transmitters now have the same list.

Saving a list

A list can be saved by sending it from an transmitter to a receiver module using the “Send” function.

The receiver module selected will store the list sent from the transmitter.

This means a list can be retrieved easily from any transmitter using the “Load” function.

7.5 "Frequency agility" automatic channel change function

Note: This function can be activated via the **Setup / Radio / Setting / mode**

Depending on the radioelectric noise in the radio channel used, or in case of consecutive passive shutdowns occurring during operation, the Receiver automatically selects another operating radio channel.

This automatic change may be triggered when the Receiver is in the following modes:

- **Safety** (the safety relays are deactivated):

The Transmitter requests start up. If it does not get a response from the Receiver, it searches for it based on a known radio channel table.

When the Receiver responds, it starts (the safety relays are activated) and the new radio channel becomes the current radio channel.

If the Receiver is not found, the Transmitter keeps the last current radio channel.

- **Operation** (when working, the safety relays are activated):

Before the receiver switches to the "safety" mode to change the radio channel, it remains on the current channel for 2 seconds in order to attempt to warn the Transmitter of this change.

If the Transmitter receives the information, it changes radio channel, the "**Safety**" alert message appears on the display screen. The link can thus be restarted by pressing the green "on" pushbutton.

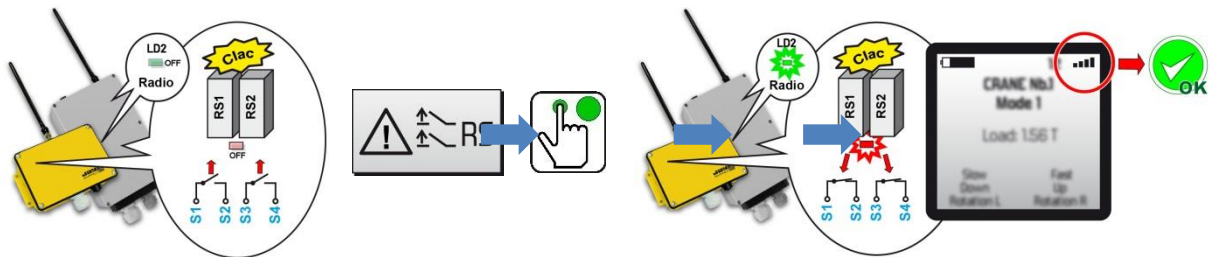

If the Transmitter has not received the radio channel change information and no message has appeared on the screen, you must shut down the Transmitter (press the stop palmswitch) and restart (press the green "on" pushbutton) so that it finds the Receiver.

7.6 "Radio power regulation" function

Note: This function can be activated via the **Setup / Radio / Power / mode**

This function enables you to regulate the radio link quality to a suitable level for the system to operate smoothly.

It does not emit more power than necessary to ensure the radio link between the Transmitter and the Receiver.

Therefore, this tool strongly limits radio spectrum pollution, and this emission principle improves the rejections of adjacent radio channels.

7.7 "Deadman" function (detection of operator inactivity)

The "**Deadman**" function is intended to protect isolated operators and/or those who work on dangerous machines.

This tool automatically triggers an alert and the shutdown of the equipment controlled if the operator stops moving (suspected malaise, fall, unconsciousness, etc.).

The operator's inactivity can be detected in two ways: either "**manually**", or "**automatically**".

7.7.1 Manual detection of operator activity

Manual detection is provided as a basic function on all Transmitter types.

Activity is checked by regular pressing at 2 to 60 second intervals on one or more buttons used by the operator.

If the "Deadman" button is not pressed or holding down by the operator for the time period configured, the Receiver safety relays are deactivated and the Transmitter is switched off.

A **pre-alarm** is triggered before the Transmitter is switched offer, signally the request to re-arm the "Deadman" counter. The pre-alarm is indicated by a symbol and may be supplemented by an alert message displayed on the transmitter screen, and in option by activating a vibrator.

7.7.2 Automatic detection of operator inactivity by inclinometer (option)

Activity is checked by an "inclinometer" installed in the Transmitter.
If there is no movement, an alert is triggered.

The inclinometer's detection sensitivity can be configured using the **iDialog** programming software or on the display screen: **Setup / Function / Dead man / auto**, use the navigation buttons to select the desired sensitivity.

7.7.3 Vibrator (option)

This option comes in addition to an alarm and can be activated at the same time as the appearance of the alarm.

Activation of the vibrator can be set using the **iDialog** programming software.

For the "dead man" function, the vibrator can alert the operator to imminent system shutdown if he does not react.

7.7.4 Configuration

The "Deadman" function can be configured via the menu: **Setup / Function / Deadman**

Note: The Receiver must be having its power on in order to synchronise data with the Transmitter.



Duration: time in seconds before a shutdown is triggered if no control system has been activated or if the inclinometer has not detected any movement. By default, a pre-alarm is triggered 5 seconds before shutdown is triggered*.

Auto (Threshold): adjustment of the movement detection sensitivity by the inclinometer. 5 levels are available, from not sensitive (-) to very sensitive (+).

* = can be changed with the programming software **iDialog**

7.7.5 Use

After starting the radio control, the activity of the operator is analyzed by the "Dead man" function. In normal use, on the Transmitter screen, a pictogram indicates the activity of the operator.

Chronogram of events:

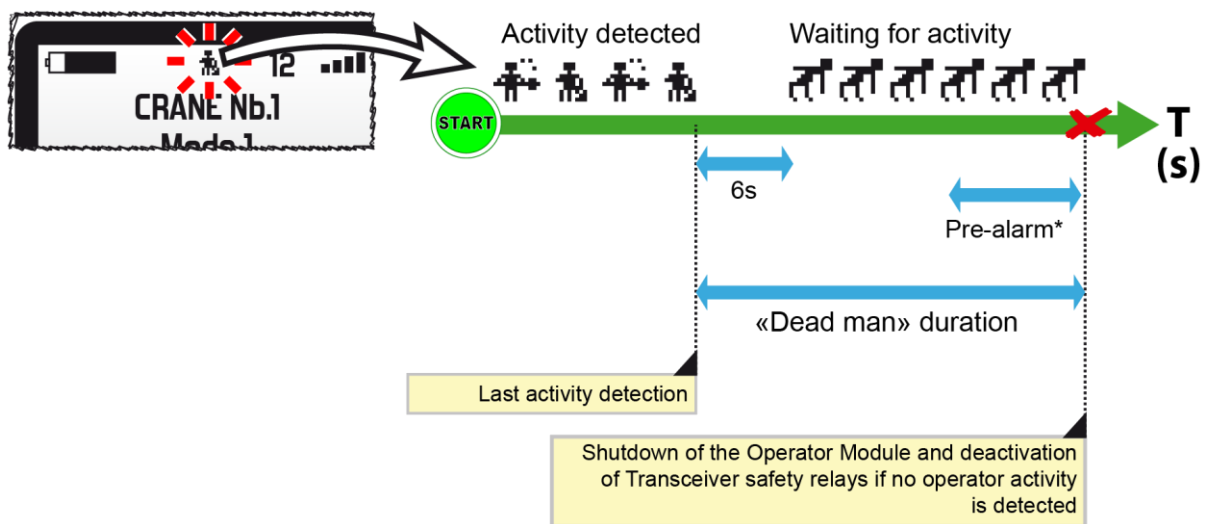

* = Duration can be changed with **iDialog** programming software. During the pre-alarm, an alert message can be displayed on the Transmitter screen and, in addition, a vibrator can be activated to warn the operator of an imminent shutdown of the system if no reset is made.

With **iDialog**, it is possible to parameterize the control elements to be actuated for the "Dead man" periodicity as well as the elements such as inclinometer, vibrator, buzzer etc ...:



(See **iDialog** operating manual: **351910**)

7.8 « Filtering of commands and anti-tapping » option

This system limits tapping commands on the command pushbuttons.

To do so, it is possible to define the minimum rest time for each command pushbutton with the **iDialog** programming software.

7.9 « Multimode 3 » and « Multimode 32 » options

With a conventional solution, each control component (joystick, selector, button, etc.) controls a function (movement, selection, etc.). It is therefore necessary to have a control component for each function to be piloted.

With the "**Multimode 3**" option it is possible to control up to **3 function sets** with each control unit and up to **32 function sets** with the "**Multimode 32**" option.

Example 1:

- In mode 1, a joystick controls the PWM outputs 1 and 2 to make the cylinder n ° 1 in / out.
- In mode 2, this joystick can control the PWM 3 and 4 outputs to control the cylinder n ° 2.
- In the 3 ... 32 mode

Example 2:

- In mode 1, a joystick controls the two tracks of a drill. (Drilling positioning)
- In mode 2, this same joystick controls the deployment of the drill arm (drill installation)
- In the 3 ... 32 mode

Example 3:

- In mode 1, the buttons are used to control the functions of the front part of a machine.
- In mode 2, these buttons control the functions of the rear part.
- In the 3 ... 32 mode

The screen informs the user about the selected mode and the functions controlled by the control components.

The user selects the desired mode using a **list** or **navigation buttons**.

- **Example 1:** N1 button to call up the list of available modes and select the desired mode.
- **Example 2:** N1 button to switch to the next mode. N2 button to go to previous mode.
- **Example 3:** N1 button to enter next mode and loop back to mode 1.

Each mode has a screen. Each display shows the current mode, the available functions and up to 3 feedbacks (3 items from the equipment).

Example:

- mode 1: Oil pressure, fuel level.
- mode 2: lift load, lifting height
- mode 3 ... 32

With the **iDialog** software, the installer defines:

- the desired number of modes (within the chosen option);
- the navigation button (s);
- the names of each mode;
- the feedbacks displayed on each mode;
- the functions controlled by each control unit.

7.10 « Inclinometer » function

Note: All transmitters can be equipped with an inclinometer except for "Gama" models.

This function allows you to continuously monitor the inclination of the Transmitter. If a predetermined inclination threshold (1) has been crossed, actions will be triggered (2) (alert message, shutdown of control actions etc.).

(1) = configurable with the Transmitter or **iDialog** programming software

(2) = configurable with **iDialog** programming software

7.10.1 Configuration

The "inclinometer" function can be set via the menu: **Setup / Function / Inclinometer**

Note: The Receiver must be powered in order to synchronize the data with the Transmitter.

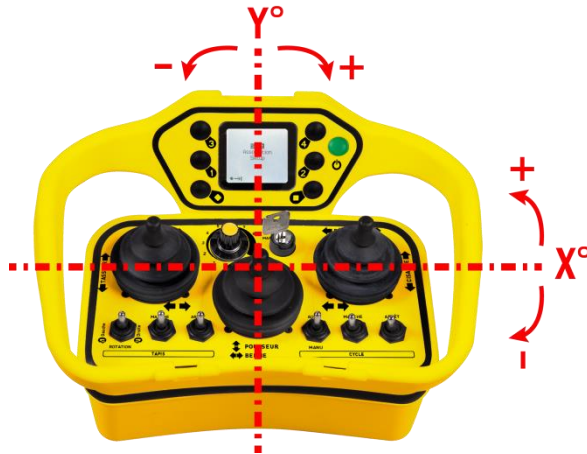
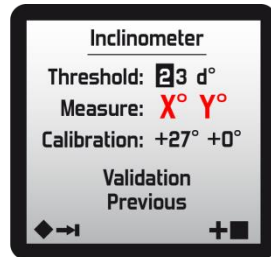

Threshold: The value of the maximum inclination of the transmitter on one of the 2 axes (X or Y), with respect to the indicated inclinations. Adjustable from 3 to 60 °.

Measure: real-time indication of the X and Y inclinations of the transmitter with respect to a horizontal reference system.

Calibration: this function sets the "normal" working position

1. Place the transmitter in its "normal" working position
2. Using the 2 navigation buttons, select "validation" and then confirm with the green pushbutton "on / horn"

Example of "normal" working position (Pika Transmitter):

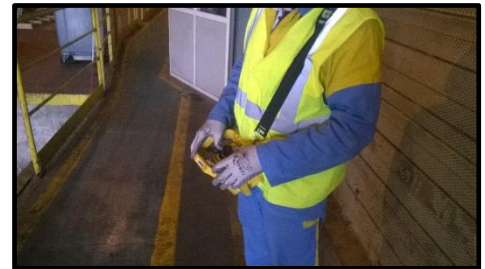

7.10.2 Use

During operation, a **pictogram** on the screen indicates the orientation of the Transmitter:

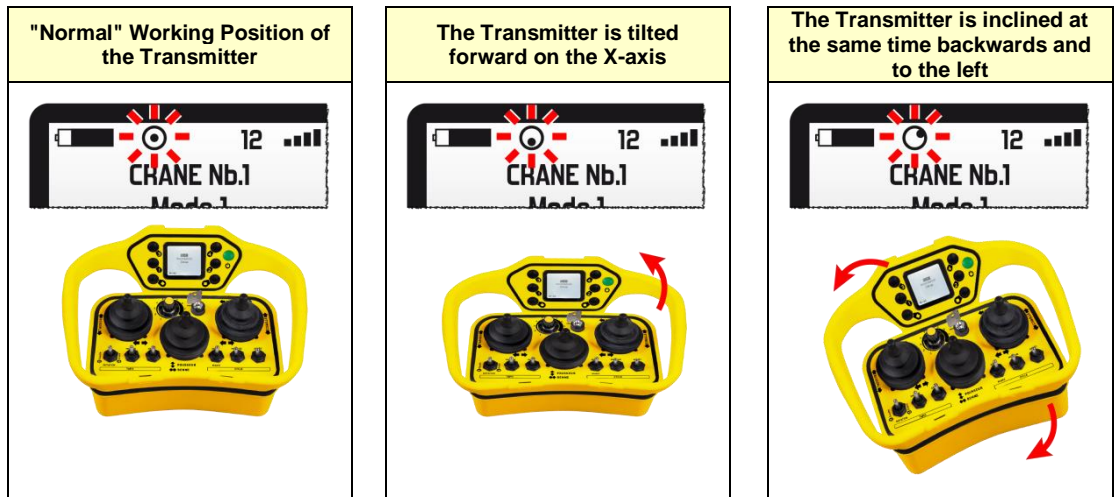

If the value **X + Threshold** or / and **Y + Threshold** is reached, an alert message appears on the screen, until the position of the slightly less inclined transmitter is returned.

Some control devices (joystick, selector switches, etc.) can be made inoperative *.

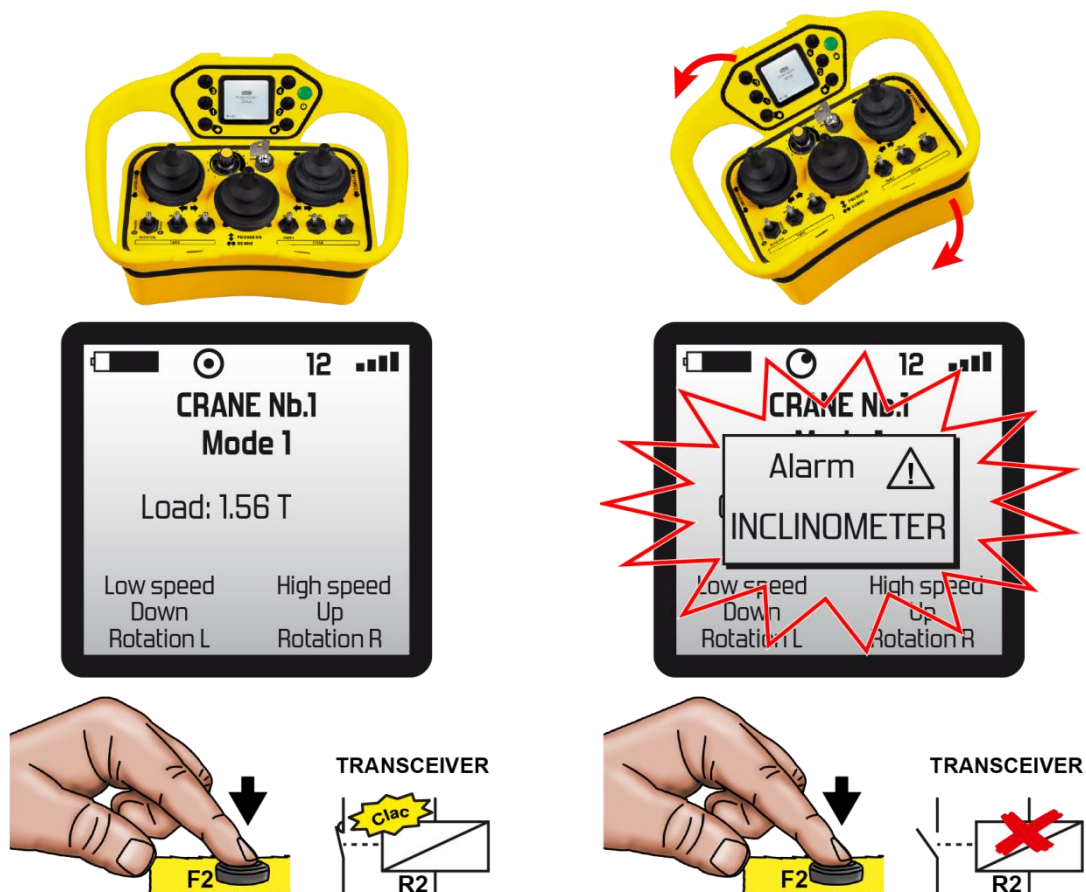

* = Requires special programming by equations, consult our technical support department.

8 Instructions for installation and commissioning

8.1 Instructions for electrical connection of the Transceiver ATEX

IMPORTANT :

IF TRANSCEIVER IS DIRECTLY SUPPLIED FROM THE NETWORK DISTRIBUTION, THE SCHEMA OF THE POWER SUPPLY NETWORK TYPE "IT"- SHALL NOT BE USED TO SUPPLY THE TRANSCEIVER.

- ⚠ ● The electrical installation must be realized by professional trained and certified.
- To avoid any risk of electrocution or explosion, never open the ATEX connection interface unit or the ATEX Transceiver unit when powered up. When accessing the interior of the unit, make sure there is no power in the electrical power supply and control cables.
- ⚠ ● Cables shall withstand a maximum temperature of conductors higher than 70°C for a maximum current per connection I_m : 4A.
- ⚠ ● The maximum current carrying capacity across the connection terminals must be observed (see chapter *Technical characteristics / Transceiver Alto-Elio and ATEX Connection interface unit*).
- The Transceiver power supply circuit must be directly related to the power supply circuit of the radio-controlled equipment.
- The Transceiver power supply circuit must have appropriate separation means (fuse (s) or circuit breaker) or benefit from the power supply circuit of radio-controlled equipment.
- When the Transceiver is supplied with 230 VAC, the power cable shall be separated from the "control" cable. In the case of use of EEC-type electrical plug, the color of the plug shall be "BLUE".

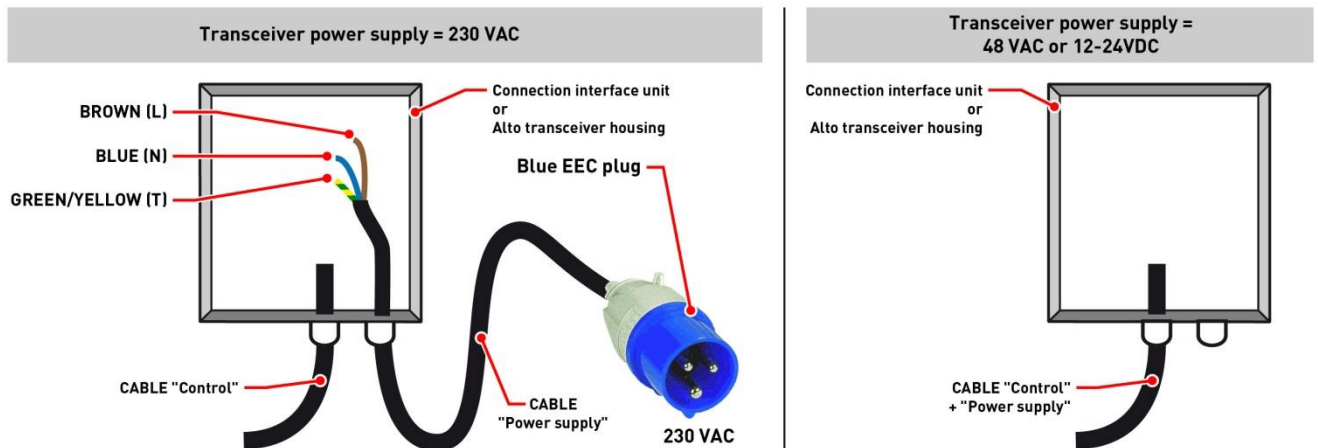

- In cable path, power cables should be separated from the control cables, by observing a minimum spacing (20 cm) between the various classes :
 - **Class 1** : Radio, analogue signals
 - **Class 2** : Mains for supply of various components,
 - **Class 3** : Power control of motors, variable speed drives, etc...If only one cable path is available, the cables of different classes should be separated as much as possible
- To maintain the reinforced insulation inside the **ATEX Connection interface unit housing and ATEX Transceiver housing**, it is mandatory to increase the insulation of cables carrying high voltages with insulating sleeves.

- **Conductor wire sections to be observed for the safety and functional relays connected to the main:**
Be sure to observe the min. /max. wire sections listed below for electrical connection:

Nominal Current A	Minimal size of connectors	
	Section mm ²	AWG or Kcmil [section in mm ²]
3	0.5	20 [0.5]
6	0.75	18 [0.8]
10	1 (0.75)	16 [1.3]

- **The type of wires used for wiring the Safety and functional relay outputs connected to the main, is mandatory:** class 1 size 18AWG with min temperature range -25°C to +60°C. The double insulation or reinforced insulation must be greater than 0.4mm.
 - Warning: If the voltage applied to the safety or functional relays is greater than 30 V rms, 42.4 V peak, or 60 V dc, the installation must comply with the rules for mechanical insulation, fire insulation according to IEC 62368-1. The installer must warrant that no wires can touch the board.
- Be sure not to exceed the minimum and maximum characteristics specified in «[Technical characteristics /Transceiver Alto-Elio](#)», section, by installing, if necessary, an additional load or intermediate relays (auxiliary contacts in electrical control cabinet for power control, for example).

8.1.1 Multi-strand wires: use of wire end ferrules is mandatory

Where flexible multi-strand wires are used, wire end ferrules must be used to avoid false contacts and short-circuits.



8.1.2 Conductor wire sections to be observed

Be sure to observe the min. /max. wire sections listed below for electrical connection of the **ATEX Transceiver** and **ATEX connection interface unit** (option) :

- Transceiver power supply circuit - Connection to function relays - Connection to safety relays	0,5mm ² to 1,5mm ²
Other type of signal	0,25mm ² to 1,5mm ²

8.1.3 Alto Transceiver wiring terminals

Power supply board



Auxiliary board

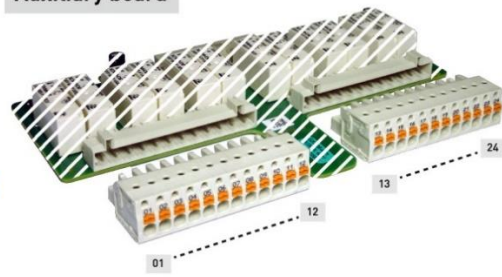

Control board

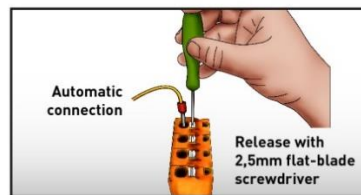
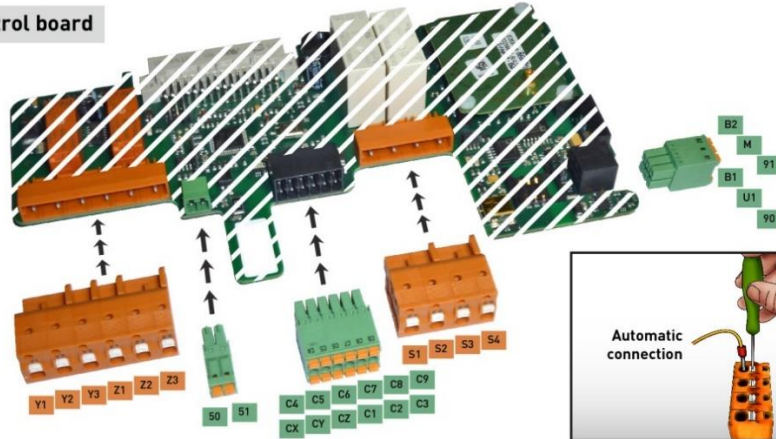

8.1.4 ATEX Connection interface unit wiring terminals

⚠ IMPORTANT : The above devices must only be installed in strict observance of the rules and constraints linked to the area in which the host units are used.

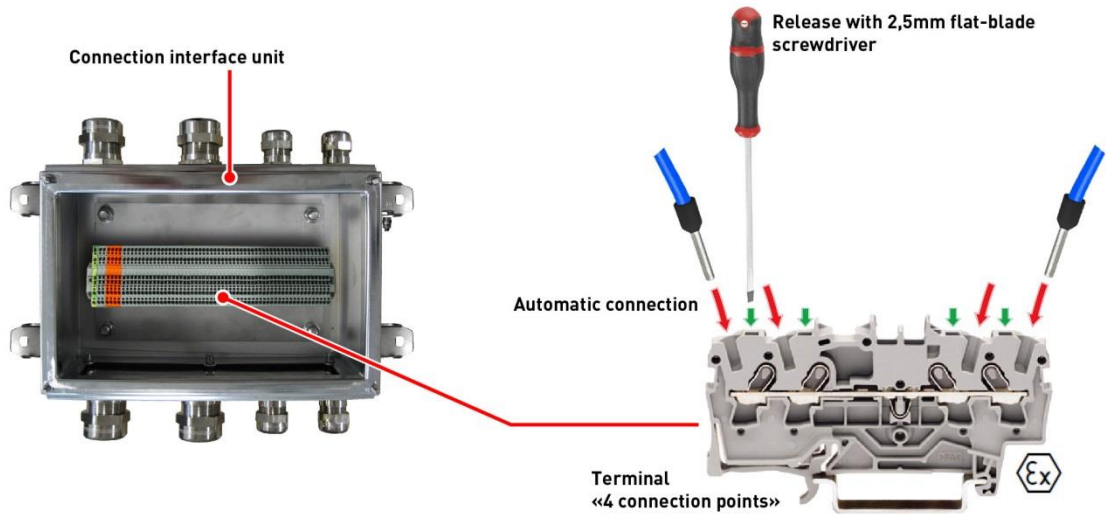

8.1.5 Interference suppression of the electrical installation and protection of the power supply

In the event of inductive loads on the ATEX Transceiver relay outputs (contactor coils, solenoid valves or electro-brakes), interference suppression devices such as capacitors, RC circuits, diodes, etc. must be placed directly at the terminals of the controlled components using the shortest possible connections. A draw resistor should also be used on the controller inputs.

Examples of protection system to be used :

⚠ IMPORTANT : The above devices must only be installed in strict observance of the rules and constraints linked to the area in which the host units are used.

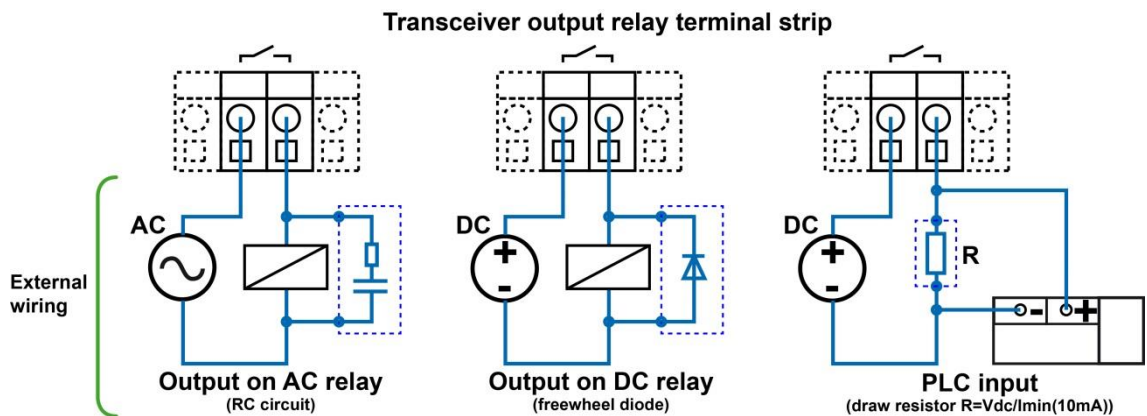

8.1.6 Use of an antenna extension

When an antenna extension is used, make sure that the structure on which the mounting bracket will be secured has the same equipotential as the structure on which the ATEX Transceiver unit is mounted.

8.2 Transceiver ATEX : Connecting the power supply



**TO AVOID ANY RISK OF ELECTROCUTION OR EXPLOSION,
NEVER OPEN THE CONNECTION INTERFACE UNIT OR THE ALTO TRANSCEIVER
UNIT WHEN POWERED UP.**
When accessing the interior of the unit, make sure there is no power in the
electrical power supply and control cables.



During any intervention requiring the opening of the transceiver Ex-Proof housing, you have to take the necessary precautions in order not to degrade the surface state of the 2 jointing planes of the cover seal.



Before closing the ex-proof housing : put in place the cover and close the inner plastic housing (6 screws)



Following any intervention requiring opening of the transceiver Ex-Proof housing, be sure to apply a layer of silicon grease (supplied with transceiver) to the jointing plane of the cover seal.



All the transceiver cover screws of ex-proof housing (18 screws) must be securely in place before the unit is switched ON.

Reminder : If flexible stranded wire is used, crimped terminations must be used to avoid false contacts and short circuits..

Use the automatic connection terminals for connection.

The conductor can be released by pressing on the release landings using a 2.5mm flat tip screwdriver.

Elio

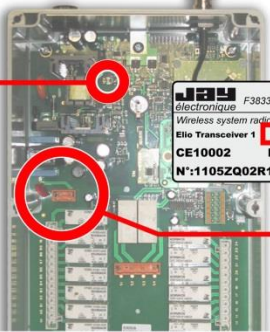

12 v.

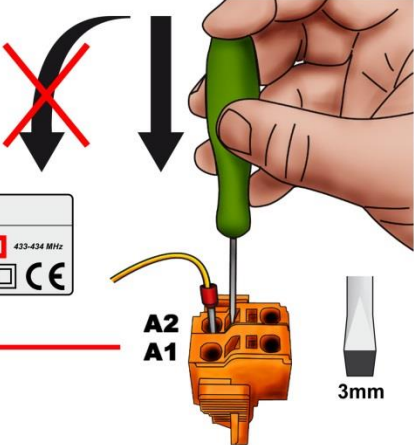

A2
A1

3mm

version A	
A1	12-24 v. DC
A2	0 v.
version B	
A1	12-24 v. DC & (L) 24-48 v. AC
A2	0 v. / (N)
version C	
A1	(L) 115-230 v. AC
A2	(N)

12 v. 

Alto

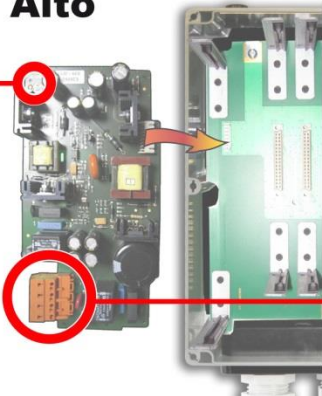

5 v. 12 v.

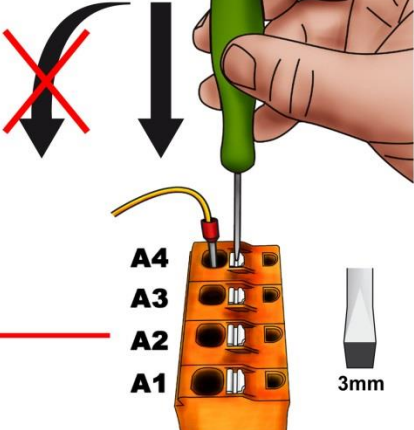

A4
A3
A2
A1

3mm

Multi	
A4	0 v.
A3	12-24 v. DC
A4	(N)
A3	(L) 24-48 v. AC
A2	(N)
A1	(L) 115-230 v. AC

5 v. 12 v. 



**NEVER USE CONTACTS
«A1/A2» AND «A3/A4»
TOGETHER**

8.3 Connection of Ground connectors

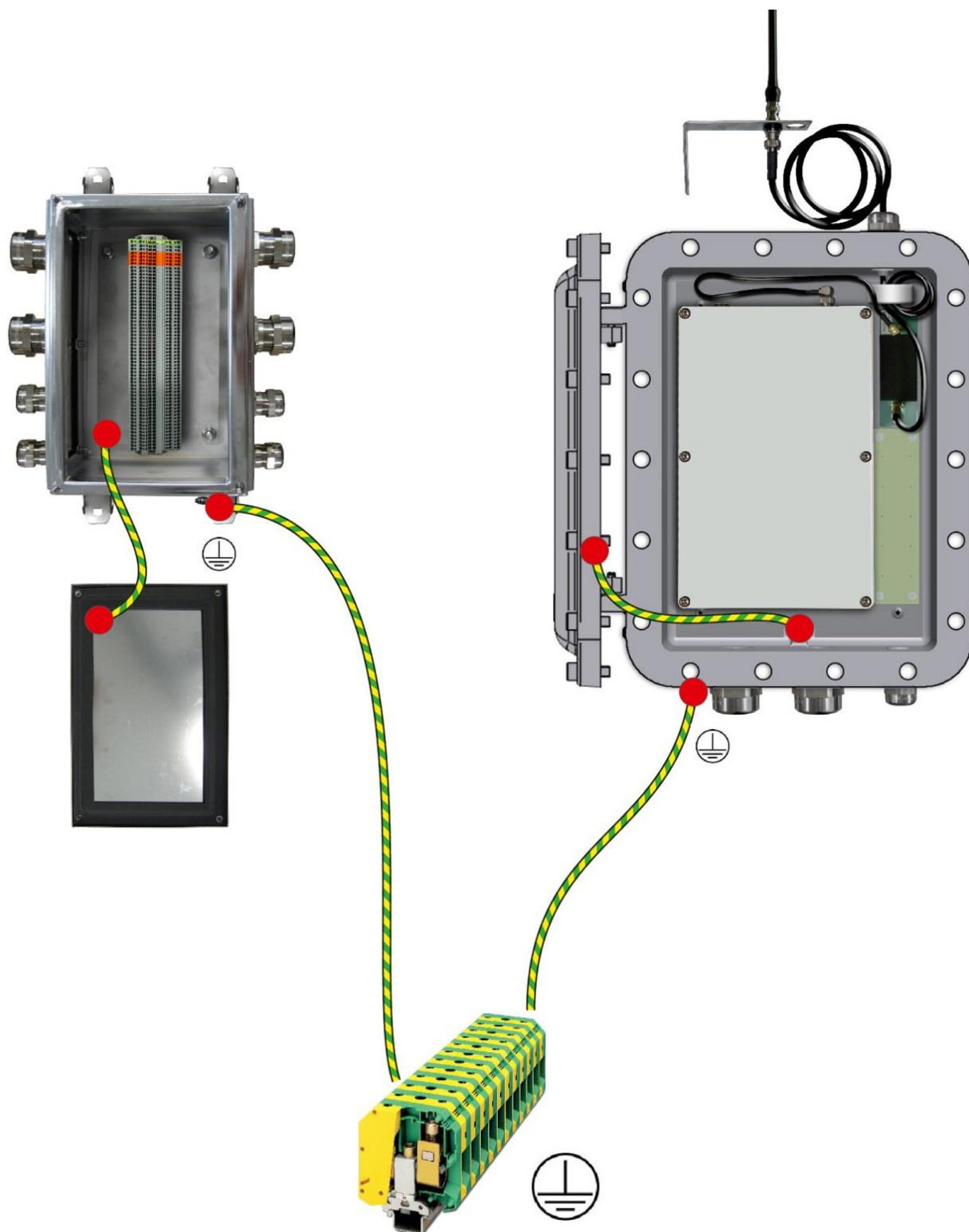

Characteristics of ground conductor : minimum wire section 4mm²

8.4 Installation of Connection unit and Transceiver

8.4.1 Cable glands

Cables are run into the **Transceiver** and into **ATEX Connection interface unit** (option) by cable glands. The cable glands are designed to ensure tightness and to anchor the cables (compliant with standard EN 50262).

Configuration of Cable glands / Covers on delivery :

- **Transceiver ATEX** = Cable glands and/or covers installed in compliance with configuration defined for order.
- **ATEX Connection interface unit** = The ATEX connection interface unit is supplied without cable glands and covers installed. A bag with these items is supplied, containing :
 - 4 cable glands M20 (nut installed using 24mm wrench)
 - 4 cable glands M32 (nut installed using 36mm wrench)
 - 4 covers M20 (nut installed using 24mm wrench)
 - 2 covers M32 (nut installed using 36mm wrench)



IMPORTANT : If cable glands or sealing elements other than those supplied by JAY Electronique are used, these components must then be certified for the types of protection **Ex e** and **Ex tb**.

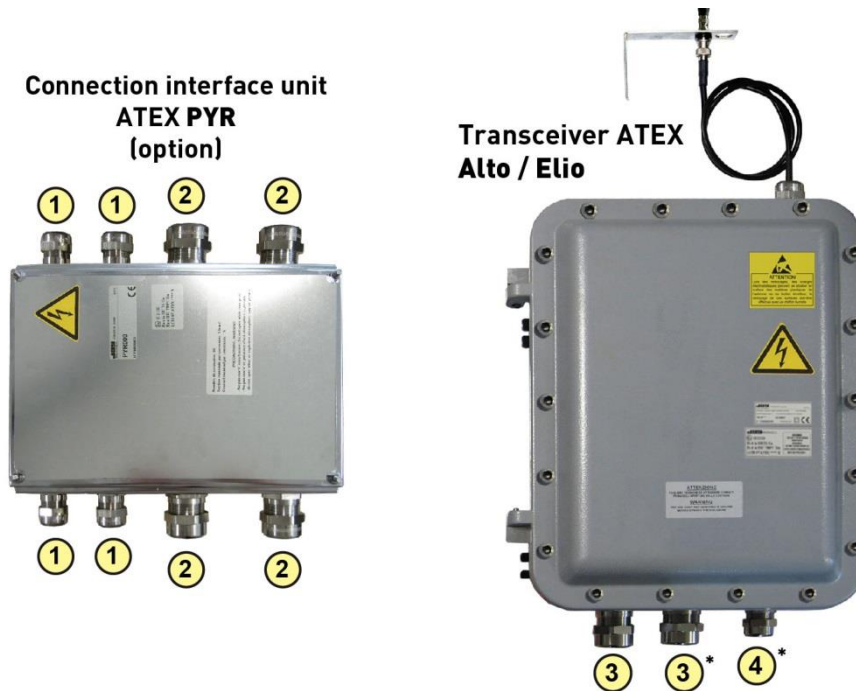

item	Type	Assembly	∅ cables (min-max)	Tool	Tightening torque
①	M20		3 rings delivered : 5,5 - 8 mm 8 - 10,5 mm** 10,5 - 13 mm	32 mm 	23Nm
④	PG 1/2" NPT Size 20 (option for Elio)				
②	M32 (for shielded cable)		3 rings delivered : 15 - 18 mm 18 - 21 mm** 21 - 24 mm	45 mm 	33Nm
③	PG 1" NPT Size 32 (for shielded cable)				

* = available as an option

** = ring mounted on delivery

8.4.2 Procedure for passage of shielded cables through cable glands

1. Place the final section of the cable in parts **E** and **D** (on shielding).
2. Remove the external sheath of the cable and cut the shielding over a length of 6 to 10 mm past the location where the sheath was cut.
3. Engage parts **C** and **B** on the cable under the shielding and the final section of the cable in the body **A** (already secured).
4. Screw on the head **E** on the body **A** and tighten to block the shielding between parts **C** and **D** and the rubber ring **B** (observe maximum tightening torque given in chapter [Cable glands](#))

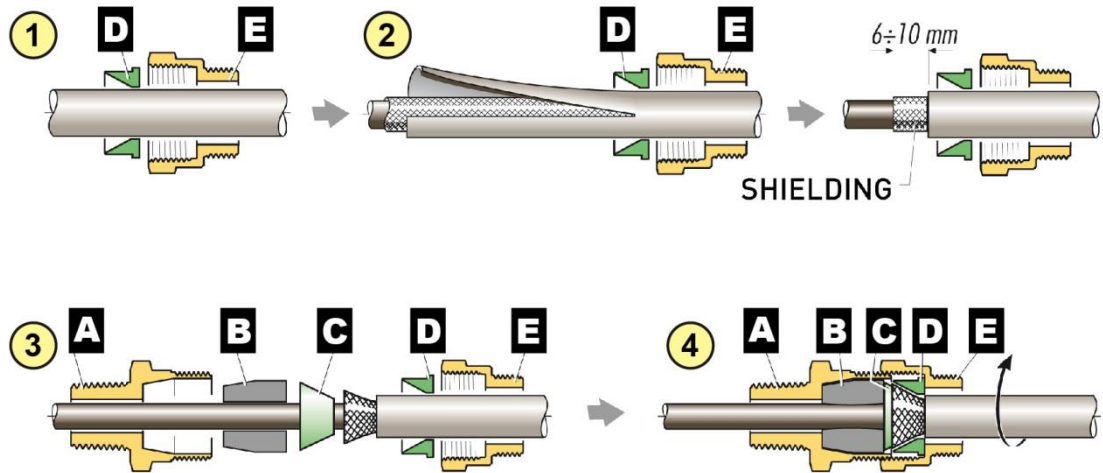

8.4.3 Installing the ATEX Transceiver and ATEX Connection interface unit

- The ATEX Transceiver and the ATEX Connection interface unit (option) must be installed in a location which is sheltered from impacts and weather, in an area which is easy to access.
- The antenna must be installed at a distance from the class 3 cables and power components (power supply, motor, variable speed drives ...) while remaining in an area which is favourable to radio reception.
- The ATEX Transceiver must be located at a height, above the operator using the transmitter, with the antenna directed downward.
- No metal object which could form a screen should be located between the operator and the antenna (risk of communication cut-out).

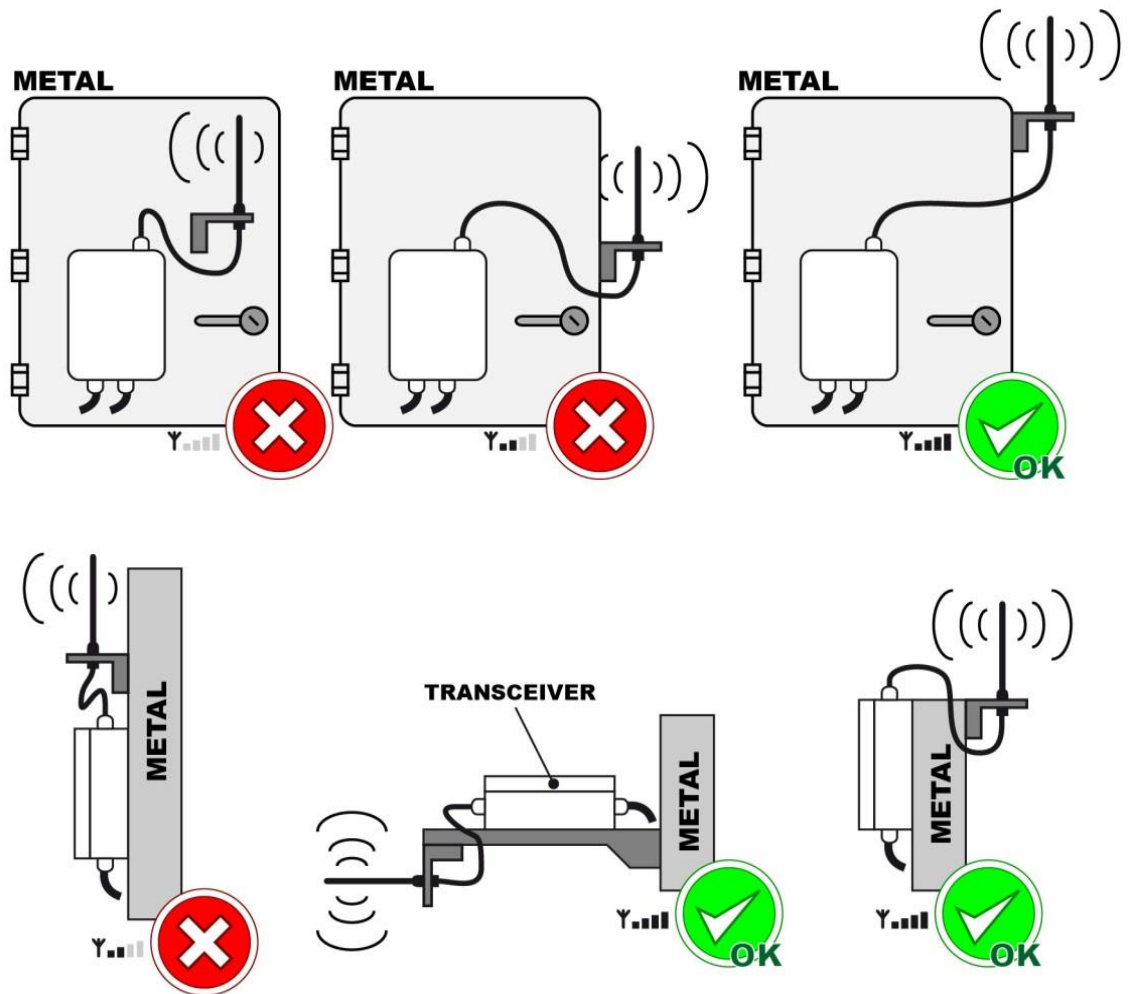

8.4.4 Mounting the ATEX Transceiver

- The installer must fit the equipment to be radio-controlled with appropriate references with respect to the operator module control components and the movements or functions of the equipment.
- The ATEX Transceiver can be secured with **screws with maximum diameter of: 10mm.**

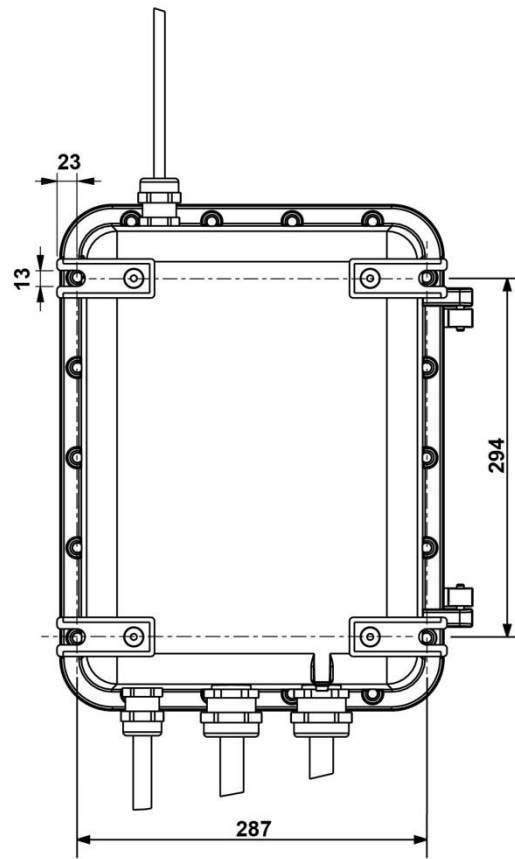

8.4.5 Mounting the ATEX PYR connection interface unit

- The ATEX PYR connection interface unit can be secured with **screws with maximum diameter of: 8mm.**

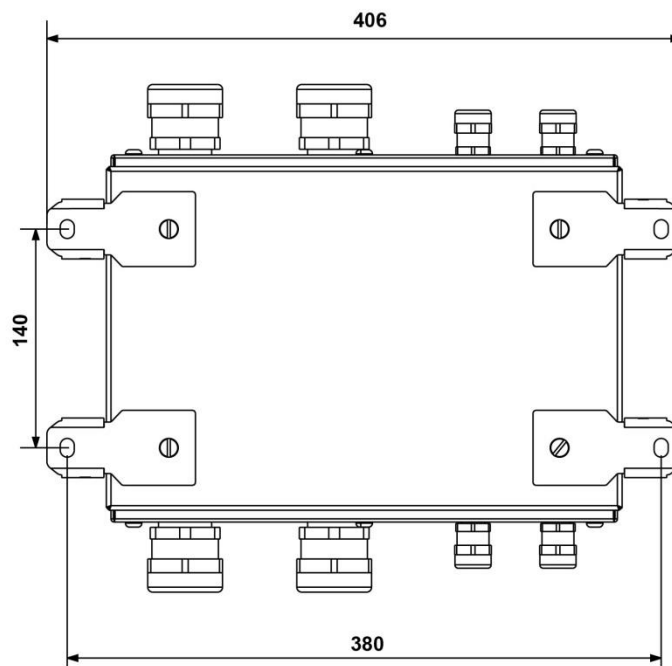

8.5 Antennas

8.5.1.1 418-419MHz and 433-434MHz Bands

<p>Antenna reference: VUA001A Type: straight, 1/4 wave, BNC connection Approximate length: 190mm</p>	 <p>Antenna supplied as standard with the Transceiver</p>
<p>Antenna reference: VUA002A Type: straight, 1/2 wave, BNC connection Approximate length: 335mm</p>	
<p>Antennas references:</p> <ul style="list-style-type: none"> • VUA100AH (with 0,5m cable) • VUA102AH (with 2m cable) • VUA105AH (with 5m cable) • VUA110AH (with 10m cable) <p>Type: through insulated remote, 1/2 wave, BNC connection Approximate length: 320mm Required drill hole: 15mm</p>	
<p>Antennas references:</p> <ul style="list-style-type: none"> • VUA103AM (with 3m cable) • VUA105AM (with 5m cable) <p>Type: insulated magnetic remote, tuned, BNC connection Approximate length: 440mm</p>	
<p>Antennas references:</p> <ul style="list-style-type: none"> • VUA103AV (with 3m cable) • VUA105AV (with 5m cable) <p>Type: through uninsulated remote, 1/4 wave, BNC connection Approximate length: 180mm Required drill hole: 12mm or 19mm (ring 2 diameters supplied)</p>	

8.5.1.2 869MHz band

<p>Antenna reference: VUA001B Frequency Range: 860-920 MHz Antenna gain: 1.5 dBi (need grounded 16x16cm) Type: straight, 1/4 wave, BNC connection Approximate length: 90mm</p>	 <p>Antenna supplied as standard with the Transceiver</p>
<p>Antenna reference: VUA002B Frequency Range: 890-960 MHz Antenna gain: 5 dB (compared to 1/4 wave) Type: straight, 1/2 wave, BNC connection Approximate length: 200mm</p>	
<p>Antennas references:</p> <ul style="list-style-type: none"> • VUA100BH (with 0,5m cable) • VUA102BH (with 2m cable) • VUA105BH (with 5m cable) • VUA110BH (with 10m cable) <p>Frequency Range: 860-960 MHz Antenna gain: 4 dBi Type: through insulated remote, 1/2 wave, BNC connection Approximate length: 190mm Required drill hole: 15mm</p>	
<p>Antennas references:</p> <ul style="list-style-type: none"> • VUA103BM (with 3m cable) • VUA105BM (with 5m cable) <p>Frequency Range: 820-960 MHz Antenna gain: 5 dBi (need grounded 60x60cm) Type: insulated magnetic remote, tuned, BNC connection Approximate length: 320mm</p>	
<p>Antennas references:</p> <ul style="list-style-type: none"> • VUA103BV (with 3m cable) • VUA105BV (with 5m cable) <p>Frequency Range: 900-920 MHz Antenna gain: 2 dBi Type: through uninsulated remote, 1/4 wave, BNC connection Approximate length: 100mm Required drill hole: 12mm or 19mm (ring 2 diameters supplied)</p>	

8.5.1.3 911-918MHz band : authorized antennas according to FCC Part 15.204

<p>Antenna reference: VUA001B Frequency Range: 860-920 MHz Antenna gain: 1.5 dBi (need grounded 16x16cm) Type: straight, 1/4 wave, BNC connection Approximate length: 90mm</p>	 <p>Antenna supplied as standard with the Transceiver</p>
<p>Antenna reference: VUA002B Frequency Range: 890-960 MHz Antenna gain: 5 dB (compared to 1/4 wave) Type: straight, 1/2 wave, BNC connection Approximate length: 200mm</p>	
<p>Antennas references: • VUA100BH (with 0,5m cable) • VUA102BH (with 2m cable) • VUA105BH (with 5m cable) • VUA110BH (with 10m cable) Frequency Range: 860-960 MHz Antenna gain: 4 dBi Type: through insulated remote, 1/2 wave, BNC connection Approximate length: 190mm Required drill hole: 15mm</p>	
<p>Antennas references: • VUA103BM (with 3m cable) • VUA105BM (with 5m cable) Frequency Range: 820-960 MHz Antenna gain: 5 dBi (need grounded 60x60cm) Type: insulated magnetic remote, tuned, BNC connection Approximate length: 320mm</p>	
<p>Antennas references: • VUA103BV (with 3m cable) • VUA105BV (with 5m cable) Frequency Range: 900-920 MHz Antenna gain: 2 dBi Type: through uninsulated remote, 1/4 wave, BNC connection Approximate length: 100mm Required drill hole: 12mm or 19mm (ring 2 diameters supplied)</p>	

8.5.1.4 2.4GHz band: authorized external antennas

<p>Antenna reference : VUC001C Radio frequency range: 2.4 GHz Antenna gain: 2 dBi Characteristic : SMA - Adjustable from 0 to 90°C Approximate length: 136x12.5 mm</p>	
<p>Antenna reference : VUC105CC Radio frequency range: 2.4 GHz Antenna gain: 1 dBi Characteristics: SMA - Can be fixed to walls and posts / IP65 / UV resistance Approximate length: 180x60 mm Cable length: 5m</p>	
<p>Antenna reference : VUC103CH Radio frequency range: 2.4 GHz Antenna gain: 3 dBi Characteristic: SMA - IP65 Approximate length: 48x50 mm Cable length: 3m</p>	
<p>Antenna reference : VUC103CM Radio frequency range: 2.4 GHz Antenna gain: 2 dBi Characteristic: SMA - Can be fixed on any metal surface thanks to its magnetic base Approximate length: 121x7.3 mm Cable length: 3m</p>	

8.6 Wiring diagram: use of safety relays RS1 and RS2

The safety relays **RS1** and **RS2** are used to interrupt the common control line of the radio-controlled equipment :

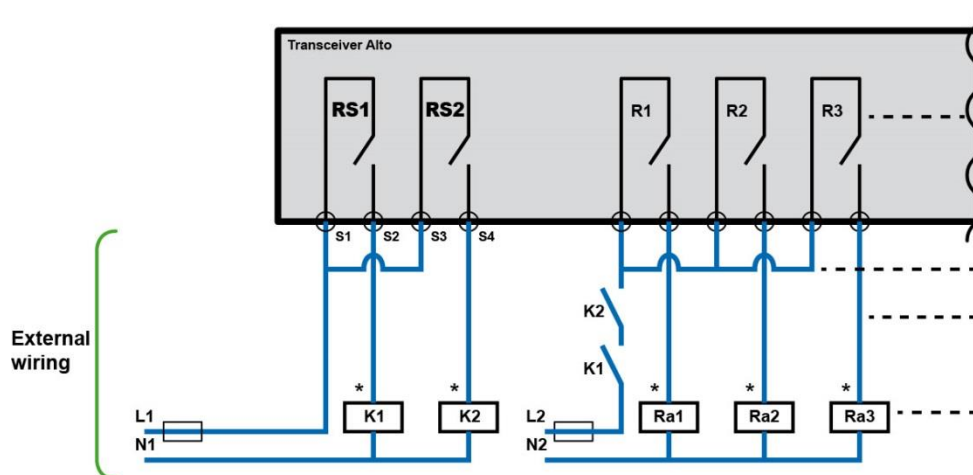

K1 and **K2** are guided contact contactors, to be integrated in the safety circuit of the system controlled.

The 2 safety relays **RS1** and **RS2** are activated when radio communication is set up between the operator modules and the Transceiver, and are automatically maintained up to the moment of active or passive shutdown (action on palm switch, loss of radio link, battery discharged, "Standby" time elapsed ...).

* = The use of overvoltage limiting circuits will increase the service life of the relay contacts (ex: RC circuits with AC, diodes + Zener with DC, etc.).

8.7 Instructions for commissioning



Before commissioning, make sure the category of equipment used in the installation satisfies the ATEX requirements of the application.

- Before commissioning, the installer must check the passive stop time setting. The value of the passive stop time is available in the menu "configuration => function => Passive stop". The stop characteristics are described in the chapter §14.3.
- Before commissioning, the installer must perform a final check to make sure of the match-up between the control components of the transmitter and the relays (or solid-state outputs) of the desired Receiver.
- During the previous check, the installer must check that when the green "On/Horn" button is pressed on startup, only the safety relays are in the "ON" state.
- **Verify the priority general shutdown mode** (remote control in operation and radio link established):

Active stop: When the stop palm switch button on the transmitter is pressed, the Receiver safety relays (RS1 and RS2) should instantaneously change state.

Passive stop: When the battery is removed from the transmitter in operation, the Receiver safety relays (RS1 and RS2) should change state within the passive stop time. The passive stop time can be configured by iDialog.

9 Maintenance

The spare parts are only accessible to persons having been appropriately trained by JAY Electronique at its training centre.

9.1 Replacement of an operator module or of a Transceiver

9.1.1 Operator modules

In the event of an operator module failure, a backup operator module can be used. To do so, perform the procedure detailed in the "**Association**" menu.

Validate the selected Transceiver; the configuration of the previous operator module used is recovered and your replacement operator module is ready to operate.

9.1.2 Transceiver



The Transceiver is equipped with a **SIM** card which can be disconnected from the management board. The SIM card contains all the configuration parameters. In the event of a failure, the card can be removed and placed in a replacement Transceiver having the same configuration (additional boards for Alto).

Transceiver Alto :



9.2 USB connector



The Operator module and the Transceiver are equipped with a mini-B USB interface. Using the **iDialog** software, this interface will allow you to display and modify the system configuration parameters. To access this connector, you must open the Transceiver unit.

9.3 Chargers

9.3.1 Indicator light on support chargers does not come on

Power supply problem (check the voltage adapter and the connection to the support charger).

9.3.2 Operator module does not charge on its support charger

Check that the contacts on the support charger are clean.

10 Inspection and servicing

BEFORE PERFORMING ANY SERVICING OPERATION, SWITCH OFF THE MAIN POWER SUPPLY OF THE CONTROL SYSTEM.

10.1 Inspection and servicing of operator module

The operator module housing must not be opened.

If one of the membranes of the function buttons or the seal of the operator module is damaged, the product must not be any more used until replacement of these tightness spare parts.

In opposite case, any liquid, any dust or any foreign body can damage the operator module.

The attention of the user is attracted to the risks of the use of the remote control in an environment containing solvents of polymers or glues which can degrade the good functioning of operator module mechanical organs.

Verify regularly the good state of the transmitter, paying a special attention to the function button membranes, to the electronic key connector and to the battery.

Clean the operator module by eliminating any foreign body.

Only use non aggressive cleaning product on base of soapy solution.

Once by year, it is necessary to check the function of Emergency stop and safety relays and the safety function relay if the product have it.

10.2 Inspection and servicing of charger







The attention of the user is attracted to the risks of the use of the remote control in an environment containing solvents of polymers or glues which can degrade the good functioning of support chargers mechanical organs.

Clean the charger by eliminating any foreign body.

Only use non aggressive cleaning product on base of soapy solution.

Check that the battery compartment remains clean and dry.

10.3 Inspection and servicing of ATEX Transceiver and ATEX Connection interface unit

 	<p>TO AVOID ANY RISK OF ELECTROCUTION OR EXPLOSION, NEVER OPEN THE CONNECTION INTERFACE UNIT OR THE ALTO TRANSCIEVER UNIT WHEN POWERED UP. When accessing the interior of the unit, make sure there is no power in the electrical power supply and control cables.</p>		
	<p>During any intervention requiring the opening of the transceiver Ex-Proof housing, you have to take the necessary precautions in order not to degrade the surface state of the 2 jointing planes of the cover seal.</p>		<p>Before closing the ex-proof housing : put in place the cover and close the inner plastic housing (6 screws)</p>
	<p>Following any intervention requiring opening of the transceiver Ex-Proof housing, be sure to apply a layer of silicon grease (supplied with transceiver) to the jointing plane of the cover seal.</p>		<p>All the transceiver cover screws of ex-proof housing (18 screws) must be securely in place before the unit is switched ON.</p>

The ATEX Transceiver housing can be dismantled only by a trained staff, in a "controlled" environment, spare parts can be changed only by identical and original parts..

Check the antenna connection and check that it is clean and free of any oxidation.

Check the wiring of Transmitter to electrical unit on power supply and machine, and wiring of function outputs.

Check the correct operation of stop circuits, active and passive :

- Active stop : When the stop palm-switch button on the operator module is pressed, the Transceiver safety relays (RS1 and RS2) should instantaneously change state.
- Passive stop : When the battery is removed from the operator module in operation, the Transceiver safety relays (RS1 and RS2) should change state within two seconds max







Clean the housing by eliminating any foreign body

**Check the condition of cover seal, tightening of 18 screws and cable glands.
Only use non aggressive cleaning product on base of soapy solution.**

11 Technical characteristics

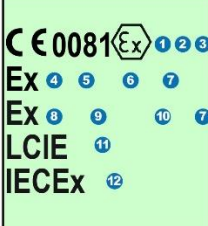
11.1 Definition of markings on ATEX - IECEx products

Since July 1st, 2003, all Ex products must satisfy the requirements of the directive ATEX 94/9/CE, the evolution of the standard 60079-0 leads to a new Ex product marking presented in the following tables :

<p>Pika ATEX Operator module</p>  <p>CE 0081 Ex II 1 G D Ex ia IIB T4 or 145°C Ga (1) Ex ia IIIC T135°C or T145°C Da (1) II 2 G D Ex ia IIC T4 or 145°C Gb (1) Ex ia IIIC T135°C or T145°C Db (1) IM1 Ex ia I Ma LCIE 15 ATEX 3058 X IECEX LCIE 15.0047 X</p> <p>+ cable link :</p> <p>CE 0081 Ex II 1 G D Ex ia IIB T4 or 145°C Ga (1) Ex ia IIIC T135°C or T145°C Da (1) IM1 Ex ia I Ma Ui : 8V; Pi : 310mW; Ci : 96.2µF; Li : 0.54µH; LCIE 15 ATEX 3058 X IECEX LCIE 15.0047 X</p>	<p>Moka ATEX Operator module</p>  <p>CE 0081 Ex II 1 G Ex ia IIB T4</p> <p>IM1 Ex ia I Ma LCIE 14 ATEX 3014 X IECEX LCIE 14.0015 X</p> <p>+ cable link :</p> <p>CE 0081 Ex II 1 G Ex ia IIB T4</p> <p>IM1 Ex ia I Ma Ui : 5.9V; Ii : 70mA; Pi : 103mW; Ci : 98.75µF; Li : 0.6µH LCIE 14 ATEX 3014 X IECEX LCIE 14.0015 X</p>	<p>Alto ATEX Transceiver</p>  <p>CE 0081 Ex II 2 GD Ex d IIB T6 Gb Ex tb IIIC T85°C Db Um ≤250 VAC LCIE 14 ATEX 3005 X IECEX LCIE 14.0014 X</p> <p>+ cable link :</p> <p>CE 0081 Ex II 2 (1) GD Ex d [ia Ga] IIB T6 Gb Ex tb [ia Da] IIIC T85°C Db Um ≤125 VAC Uo:5.9V ; Io:210mA, Po:310mW Co:1000µF ; Lo:3.22mH, LoRo: 460µHΩ LCIE 14 ATEX 3005 X IECEX LCIE 14.0014 X</p>	
<p>Gama ATEX Operator module</p>  <p>CE 0081 Ex II 1 G D Ex ia IIB T4 or 145°C Ga (1) Ex ia IIIC T135°C or T145°C Da (1) II 2 G D Ex ia IIC T4 or 145°C Gb (1) Ex ia IIIC T135°C or T145°C Db (1) IM1 Ex ia I Ma LCIE 15 ATEX 3055 X IECEX LCIE 15.0045 X</p>	<p>Beta ATEX Operator module</p>  <p>CE 0081 Ex II 1 G Ex ia IIB T4 or 145°C Ga (1) Ex ia IIIC T135°C or T145°C Da (1) II 2 G D Ex ia IIC T4 or 145°C Gb (1) Ex ia IIIC T135°C or T145°C Db (1) IM1 Ex ia I Ma LCIE 14 ATEX 3055 X IECEX LCIE 14.0049 X</p>	<p>Elito ATEX Transceiver</p>  <p>CE 0081 Ex II 2 GD Ex d IIB T6 Gb Ex tb IIIC T85°C Db LCIE 15 ATEX 3023 X IECEX LCIE 15.0025 X</p>	<p>Kit PYA Output BNC antenna kit with intrinsic safety barrier</p>  <p>CE 0081 Ex II 1 GD Ex ia IIC Ga Ex ia IIIC Da Ex ia I M1 LCIE 14 ATEX 3004 U IECEX LCIE 14.0006 U</p> <p>(1) Temperature classes depending on Tamb : -20°C ≤ Tamb ≤ +40°C, temperature classes are T4 for gas and T135°C for dust; +40°C ≤ Tamb ≤ +50°C, temperature classes are 145°C for gas and T145°C for dust.</p>

1 Device group

Device group	Application
Group I	Electrical devices intended for use in firedamp mines. (underground work in the mines and parts of ground installations) => Protection against firedamp
Group II	Electrical devices intended for all other explosible atmospheres than firedamp mines (ground industries) => Protection against explosions

2 3 ATEX classification

Category of equipment	Flammable substances	Degree of protection	Description
1	G Gas D Dust	Very high level	Devices capable of operating in the atmospheres where the risk of explosion is permanent or almost permanent (zones 0, 1, 2 and 20, 21, 22)
2	G Gas D Dust	High level	Devices capable of operating in the atmospheres where the risk of explosion is frequent (zones 1, 2 and 21, 22)
3	G Gas D Dust	Normal	Devices capable of operating in the atmospheres where the risk of explosion is occasional (zones 2 and 22)

(.) : The information in brackets indicates that it is possible to connect the cable link option to an operator module which is certified in category 1.

4 Protection modes for electrical equipment in gaseous atmospheres

Protection mode	Standard	Basic principle	Application in ZONE		
			0	1	2
d Explosion proof enclosure	EN/IEC 60079-1	The extremely heavy duty enclosure contains the explosion inside the device. The explosion proof seals of the device prevent any propagation of the flame outside the enclosure. The seals are regularly serviced.	●	●	●
e Enhanced safety	EN/IEC 60079-7	The components inside the enclosure must not produce arcs, sparks or dangerous temperatures under normal utilization conditions. The enclosure must be tight to IP 54 and withstand impacts.	●	●	●
i Intrinsic safety	ia EN/IEC 60079-11	The actual design of the circuit, where the energy is limited at the entry by a Zener barrier or a galvanic insulator makes it impossible for arcs or electrical sparks to form, subdivided into "ia" resists 2 defects: suitable for zone 0, and "ib" resists 1 defect: suitable for zones 1 and 2.	●	●	●
	ib EN/IEC 60079-11	The actual design of the circuit, where the energy is limited at the entry by a Zener barrier or a galvanic insulator makes it impossible for arcs or electrical sparks to form, subdivided into "ia" resists 2 defects: suitable for zone 0, and "ib" resists 1 defect: suitable for zones 1 and 2.	●	●	●
m Encapsulation	EN/IEC 60079-18	For this protection mode, all the electronics is encapsulated in an insulating material to prevent electrical arcs or electrical sparks.	●	●	●
n Zone 2	EN/IEC 60079-15	This protection mode is only suitable for devices intended for zone 2 where the risk of explosion is low. It combines the enhanced safety mode "e" with lower protection requirements.	●	●	●
o Immersion in oil	EN/IEC 60079-6	The material or the electrical circuit is immersed in oil. The explosive mixture is located above the liquid and cannot be ignited by the electrical circuit.	●	●	●
p Internal overpressure	EN/IEC 60079-2	A pressurized gas is introduced in the enclosure to prevent the possibly-explosive surrounding atmosphere from entering the enclosure.	●	●	●
q Powdery filler	EN/IEC 60079-5	For this protection mode, all the electronics is encapsulated in an inert powdery material to prevent electrical arcs or electrical sparks.	●	●	●

[] : The information in brackets indicates the type of protection and the level of protection for the cable link option..

5 Classification of gases and fumes by explosion groups (non-exhaustive list)

Group IIA		Group IIB		Group IIC
Propane	Acetone	Ethylene	Ethyl oxide	Acetylene
Ethane	Hexane	Diethylene	Sulphuretted hydrogen	Hydrogen
Butane	Methanol	Ethyl ether	Ethanol	Carbon disulfide
Benzene	Paint thinners	Cycloprodene		
Pentane	Natural gas	Butadiene 1-3		
Heptane		Propylene oxide		

6 Gas temperature classes

The safe use of equipment in dangerous areas requires knowledge of the gas group and compare the temperature auto-ignition of gaseous mixtures treated to the temperature of equipment marking.

The maximum surface temperature of the material must always be less than the autoignition temperature of the gas present in the dangerous area.

Temperature class	MAXIMUM surface temperature of electrical equipment	Ignition temperatures of FLAMMABLE materials
T1	450°C	> 450°C
T2	300°C	> 300°C
T3	200°C	> 200°C
T4	135°C	> 135°C
T5	100°C	> 100°C
T6	85°C	> 85°C

7 Equipment protection level (EPL)

Traditional relationship between level of protection and areas / categories (without additional risk assessment).

Equipment protection level (EPL)	Normal range of application	Category (94/9/CE)
Ga	0 (and 1 and 2)	1G
Gb	1 (and 2)	2G
Gc	2	3G
Da	20 (and 21 and 22)	1D
Db	21 (and 22)	2D
Dc	22	3D
Ma / Mb	mines	M1 / M2

8 Protection modes for electrical equipment in dusty atmospheres

Protection mode		Standard	Basic principle	Application in ZONE		
				20	21	22
i	Intrinsic safety	ia ENIEC 60079-11	The actual design of the circuit, where the energy is limited at the entry by a Zener barrier or a galvanic insulator makes it impossible for arcs or electrical sparks to form, subdivided into "ia" resists 2 defects: suitable for zone 0, and "ib" resists 1 defect: suitable for zones 1 and 2.	●	●	●
		ib ENIEC 60079-11	The actual design of the circuit, where the energy is limited at the entry by a Zener barrier or a galvanic insulator makes it impossible for arcs or electrical sparks to form, subdivided into "ia" resists 2 defects: suitable for zone 0, and "ib" resists 1 defect: suitable for zones 1 and 2.	●	●	●
m	Encapsulation	ENIEC 60079-18	For this protection mode, all the electronics is encapsulated in an insulating material to prevent electrical arcs or electrical sparks.	●	●	●
p	Internal overpressure	ENIEC 60079-2	A pressurized gas is introduced in the enclosure to prevent the possibly-explosive surrounding atmosphere from entering the enclosure.	●	●	●
t	Explosion proof enclosure	ENIEC 60079-31	The extremely heavy duty envelope contains the explosion inside the device. The explosion proof seals of the device prevent any propagation of the flame outside the enclosure. The seals are regularly serviced.	●	●	●

9 Classification of dust by explosion groups

Explosion groups	Type of dust	Fundamental principle
Group IIIA	Combustible dust in suspension	Very fine solid particles of nominal size of about 500 microns or less, can be suspended in the air, which can be deposited because of their own weight and that can burn or be consumed in the air
Group IIIB	Non-conductive dust	Combustible dust electrical resistivity greater than $10^3 \Omega.m$. Size < 500 μm
Group IIIC	Conductive dust	Combustible dust electrical resistivity at or below $10^3 \Omega.m$. Size < 500 μm

10 Maximum surface temperature for dusty atmospheres





11 LCIE : certificate of EC type examination number

12 LCIE : IECEx certificate number

13 Intrinsic safety parameters of cable link

14 Maximum power supply voltage

11.2 ATEX Transmitters

	Moka ATEX	Pika ATEX	Gama ATEX	Beta ATEX
				
	Areas of use : Zones 0 , 1, 2, 20, 21, 22 and mines Protection mode : Intrinsic safety			
ATEX characteristics	Marking for Moka ATEX : C E 0081 (E) II 1 G Ex ia IIB T4 Ga I M1 Ex ia I Ma IECEx LCIE 14.0015X LCIE 14 ATEX 3014X Marking for Moka ATEX with cable link : C E 0081 (E) II 1 G Ex ia IIB T4 Ga I M1 Ex ia I Ma Ui : 5.9V; Ii : 70mA; Pi : 103mW; Ci:96.78µF; Li : 0.6µH IECEx LCIE 14.0015X LCIE 14 ATEX 3014X	Marking for Pika ATEX : C E 0081 (E) II 1 G D Ex ia IIB T4 or 145°C Ga (1) Ex ia IIIC T135°C or T145°C Da (1) II 2 G D Ex ia IIC T4 or 145°C Gb (1) Ex ia IIIC T135°C or T145°C Db (1) I M1 Ex ia I Ma LCIE 15 ATEX 3058X IECEx LCIE 15.0047X Marking for Pika ATEX with cable link : C E 0081 (E) II 1 G D Ex ia IIB T4 or 145°C Ga (1) Ex ia IIIC T135°C or T145°C Da (1) I M1 Ex ia I Ma Ui : 8V; Pi : 310mW; Ci:96.2µF; Li : 0.54µH LCIE 15 ATEX 3058X IECEx LCIE 15.0047X	Marking for Gama ATEX : C E 0081 (E) II 1 G D Ex ia IIB T4 or 145°C Ga (1) Ex ia IIIC T135°C or T145°C Da (1) II 2 G D Ex ia IIC T4 or 145°C Gb (1) Ex ia IIIC T135°C or T145°C Db (1) I M1 Ex ia I Ma LCIE 15 ATEX 3055 X IECEx LCIE 15.0045 X	Marquage Beta ATEX : C E 0081 (E) II 1 G D Ex ia IIB T4 or 145°C Ga (1) Ex ia IIIC T135°C or T145°C Da (1) II 2 G D Ex ia IIC T4 or 145°C Gb (1) Ex ia IIIC T135°C or T145°C Db (1) I M1 Ex ia I Ma IECEx LCIE 14.0049X LCIE 14 ATEX 3055X
	(1) Temperature classes depending on Tamb: -20°C ≤ Tamb ≤ +40°C, temperature classes are T4 for gas and T135°C for dust. +40°C ≤ Tamb ≤ +50°C, temperature classes are 145°C for gas and T145°C for dust.			
Housing material	Modified shock-proof polyamide with anti-static charge		Shock-resistant reinforced ABS with anti-static charge	
Tightness	IP65			
Weight (with battery)	1800g max	1400g max	6 + 4 buttons : 768 g 10 + 4 buttons : 893g	2 + 4 buttons : 400 g 6 + 4 buttons : 485 g
Dimensions	297 x 215 x 170 mm	243 x 180 x 170 mm	6 + 4 buttons : 290 x 93 x 64 mm 10 + 4 buttons : 360 x 93 x 64 mm	2 + 4 buttons : 182 x 75 x 50 mm 6 + 4 buttons : 235 x 75 x 50 mm
Operating temperature range	-20°C to + 50°C			
Storage temperature range of housing alone	-20°C to + 70°C			
Storage temperature range of battery	-20°C to + 50°C			
Power supply	Plug-in Li-ion battery			2 + 4 buttons : internal Li-ion battery 6 + 4 buttons : plug-in Li-ion battery
Endurance (25°C) with radio link activated	10 hours			
Frequencies on 418-419 MHz band	11 frequencies	(currently under approval)	(currently under approval)	11 frequencies
Frequencies on 433-434 MHz band	64 frequencies			
Frequencies on 869 MHz band	12 frequencies			
Frequencies on 911-918 MHz band	64 frequencies			
Transmit power	< 10 mW (license free)			
Range limitation	10 power levels, configurable			
Modulation	FM			
Average range in industrial space (2)	100 m			
Average range in open space (2)	300 m			
Charging time (endurance > 80%)	3 Hours (20min of charge get 1h autonomy)			
Charging temperature range	0°C to + 40°C			
Display	Backlit LCD display 128 x 128 pixels, 42mm (L) x 40mm (H), BLACK/WHITE			
USB interface (3)	mini-B 5-point USB connector (configuration and diagnostics)			
Emergency stop	2 positions with rotary unlock system			

	Characteristics relating to the frequency range (available for each MO)				
Frequency range	419MHz	433 - 434.7MHz	869 MHz	911MHz	2.4 - 2.48GHz
Number of channels /modulation	11/FSK	64/FSK	12/FSK	64/FSK	64/DSSS
Power Level step	15	15	5	5	10
Power (regulation)	< 10mW	< 10mW	< 5mW	< 1mW	< 10mW
Range in industrial space (Maximum levels) (1)	12m - 50m	12m - 50m	30m - 110m	15 - 75m	10m - 40m
Range in open space (maximum levels) (1)	100m - 250m	100m - 250m	210m - 570m	140m - 380m	100m - 150m
Antenna	Internal antenna	Internal antenna	Internal antenna	Internal antenna	Internal antenna

(1) = Range will vary according to environment conditions of transmitter and reception antenna (metal frameworks, walls ...).





The range is halved every 2 power levels.

The announced ranges are with "remote antenna".

(2) = Diagnosis and programming is carried out using the **iDialog** software (optional).

(3) = Excluding Gama and Pika ATEX

11.3 ATEX Transceivers: Alto and Elio

	Transceiver Alto ATEX	Transceiver Elio ATEX
		
ATEX Characteristics	Areas of use : Zones 1, 2, 21 and 22 Protection mode : Explosion proof enclosure + Intrinsic safety for cable link option	
	Marking for Transceiver Alto ATEX :	Marking for Transceiver Alto ATEX + cable link :
	CE 0081  II 2 GD Ex d IIB T6 Gb Ex tb IIIC T85°C Db Um ≤250 VAC LCIE 14 ATEX 3005 X IECEX LCIE 14.0014 X	CE 0081  II 2 (1) GD Ex d [ia Ga] IIB T6 Gb Ex tb [ia Da] IIIC T85°C Db Um ≤125 VAC Uo:5.9V ; Io:210mA, Po:310mW Co:1000µF ; Lo:3.22mH, Lo/Ro: 460µH/Ω LCIE 14 ATEX 3005 X IECEX LCIE 14.0014 X
	Marking for Transceiver Elio ATEX :	
CE 0081  II 2 GD Ex d IIB T6 Gb Ex tb IIIC T85°C Db LCIE 15 ATEX 3023 X IECEX LCIE 15.0025 X		
(1) Temperature classes depending on Tamb: -20°C ≤ Tamb ≤ +40°C, temperature classes are T4 for gas and T135°C for dust. +40°C ≤ Tamb ≤ +50°C, temperature classes are 145°C for gas and T145°C for dust.		
Housing material	Aluminium alloy marine grade	Aluminium alloy marine grade
Closing the housing	18 stainless steel screws	18 stainless steel screws
Tightness	IP66	
Weight (equipped housing)	26 kg	26 kg
Dimensions (without antenna and Cable glands)	340 x 415 x 258,3 mm	340 x 415 x 258,3 mm
Operating temperature range	-20°C to + 55°C	-20°C to + 55°C
Storage temperature range	-30°C to + 70°C	-30°C to + 70°C
Cable lead-out	- 1 cable gland PG 1 " NPT Size 32 passageway for shielded control cables / power supply - 1 cable gland PG 1 " NPT Size 32 passageway for shielded control cables / power supply (in OPTION) - 1 cable gland PG 1/2 " NPT Size 20 for cable link (in OPTION)	- 1 cable gland PG 1 " NPT Size 32 passageway for shielded control cables / power supply - 1 cable gland PG 1 " NPT Size 32 passageway for shielded control cables / power supply (in OPTION) - 1 cable gland PG 1/2 " NPT Size 20 for auxiliary control (in OPTION)
Cable glands material	Brass with nickel plating	Brass with nickel plating
Power supply	115-230VAC (- 15% / Max voltage = Um ≤ 250VAC, Max current = Im ≤ 4A per connection) (4) 24-48VAC (+/- 25%) 12-24VDC (+/- 15%) Internal protection of the power supply: Against polarity inversions for DC versions Against overcurrents by fuse : T 3,15A (DC), T 500mA (AC)	Version A : 12 VDC - 12 % to 24 VDC +25 % Version B : 12 VDC - 5 % to 24 VDC +25 % and 24/48 VAC 25 % Version C : 115/230 VAC 15 % (Max current = Im ≤ 4A per connection) Internal protection of the power supply: Against polarity inversions for DC versions Against overcurrents by fuse : T 3,15A (DC), T 500mA (AC)
Maximum consumption	20 W	8 W
Response time	See characteristics of additional relay boards On startup : 0,5s max On command : 200ms max	On startup : 0,5s max On command : 300ms max
Stop times	Active : 100 ms Passive : adjustable from 0,3 to 2s (IDialog)	Active : 100 ms Passive : adjustable from 0,3 to 2s (IDialog)
USB Interface (3)	mini-B 5-point USB connector (configuration and diagnostics with IDialog)	mini-B 5-point USB connector (configuration and diagnostics with IDialog)
Safety relays RS1 and RS2 characteristics	Relays with linked contacts • Contacts : AgNi10+Au5µm • Maximum power at cosphi=1 : 2000 VA • Maximum permissible current (at 20°C) : 8A (IMPORTANT : Do not exceed max 4A per safety relay, per LCIE certification test) • Maximum voltage switching : 250 VAC • Minimum current / voltage advised switching : 50 mA / 12 VDC • Electrical life : 100 000 switching cycles at 250 VAC, 6 A, cosphi=1 (IMPORTANT : Do not exceed max 4A per safety relay, per LCIE certification test) • Tests per EN 60947-5-1 : DC13 at 2 A / 24 VDC - AC15 at 1 A / 230VAC	Relays with linked contacts • Contacts : AgNi10+Au5µm • Maximum power at cosphi=1 : 2000 VA • Maximum permissible current (at 20°C) : 8A (IMPORTANT : Do not exceed max 4A per safety relay, per LCIE certification test) • Maximum voltage switching : 250 VAC • Minimum current / voltage advised switching : 50 mA / 12 VDC • Electrical life : 100 000 switching cycles at 250 VAC, 6 A, cosphi=1 (IMPORTANT : Do not exceed max 4A per safety relay, per LCIE certification test) • Tests per EN 60947-5-1 : DC13 at 2 A / 24 VDC - AC15 at 1 A / 230VAC
Function relays characteristics	See characteristics of additional board	2 connection points, potential free, by contact Spring-type plug-in connectors Function relays : 1 «ON» relay + 12 function relays Independent NO relays : • Category DC13 0,5A / 24VDC . AC15 2A / 230VAC • Interrupting capacity max. 2000VA • Max. current 8A • Min. current 10 mA (12 Vmin.) • 100 000 switching cycles at 250 VAC, 8A, cosphi=1 • Max. voltage 250VAC

Note: The safety relays must be protected against over current by adding a fuse 4A / 250Vac /T. The fuse is not provided by JAY electronique.

Note : Be careful when ALTO-ELIO products are used with an input voltage of 12Vdc, the power supply requires a strong starting current (10A/5µs).

	Characteristics relating to the frequency range (available for each MT)				
Frequency range	419MHz	433 - 434.7MHz	869 MHz	911MHz	2.4 - 2.48GHz
Number of channels /modulation	11/FSK	64/FSK	12/FSK	64/FSK	64/DSSS
Power Level step	15	15	5	5	10
Power (regulation)	< 10mW	< 10mW	< 5mW	< 1mW	< 10mW
Range in industrial spave (Maximum levels) (1)	12m - 50m	12m - 50m	30m - 110m	15 - 75m	10m - 40m
Range in open space (maximum levels) (1)	100m - 250m	100m - 250m	210m - 670m	140m - 380m	100m -150m
Antenna	External antenna, BNC connector, type, 1/4 Wave		External antenna, BNC connector, type, 1/2 Wave		External antenna, both SMA connector, type, 1/2 Wave

(1) = Range will vary according to environment conditions of transmitter and reception antenna (metal frameworks, walls ...).
The range is halved every 2 power levels.

The announced ranges are with "remote antenna".

(2) = Diagnosis and programming is carried out using the **iDialog** software (optional).

(3) = Power supply limited to 125VAC if presence of:

- logic and / or analog signals at inputs



- Moka / Alto wired link

11.3.1 Transceiver Alto ATEX : CONTROL Board

ELECTRICAL CHARACTERISTICS OF CONTROL BOARD	
Safety relay	
Contact type	3 relays with linked contacts
Contacts and connection	2 connection points per outputs Spring-type plug-in connection
Indication	
Radio status and quality	1 Green indicator light:
Power on	1 yellow indicator light:
fault and diagnostic	1 red indicator light:
1 Logic input	
Contats and connection	2 connection points, 1 contact spring-type plug-in connectors
Input current	< 10mA
Voltage	0-30Vdc
Low level on input	<2Vdc
High level on input	> 3Vdc
1 Analog input	
Contats and connection	2 connection points, 1 contact spring-type plug-in connectors
Max. input level	10Vdc or 4-20mA
1 active input consumption	<12mA
1 RS485 serial link	
Contats and connection	2 connection points, 1 contact spring-type plug-in connectors
Protocol	ModBus RTU slave
Data rate	1200, 2400, 4800, 9600, 19200, 38400, 57600, 115200 bit/s
Parity	None / even (default) / odd
Slave addressing	1 to 247
Outputs independent relay	1
Contacts and connection	2 connection points spring-type plug-in connection
Category	DC13 0.5A / 24 VDC, AC15 2A / 230VAC
Interrupting capacity	2000VA max.

Max. current	8A (control relay)
Min. current	10 mA (12VDC min)
Max. voltage	250 VAC
Startup by IR validation (on control board – option)	
Action area limitation by infrared (on control board – option)	
Selection and association between operator modules and transceiver by infrared (on control board – option)	

11.3.2 Transceiver Alto ATEX : auxiliary boards

ELECTRICAL CHARACTERISTICS OF BOARD WITH 12 CONTROL RELAY OUTPUTS	
Contacts and connection	2 connection points per output spring-type plug-in connection
Outputs	Independent relays - Category DC13 0.5A / 24 VDC, AC15 2A / 230VAC - Interrupting capacity, 2000VA max. - Max. current 8A  - Min. current 10 mA (12VDC min) - Max. voltage 250 VAC
	The functional relay must be protected against over current by adding a fuse 5A / 250 VAC/T. The fuse is not provided by JAY électronique
Response time	- On startup: 0.5s max. - On command: 200ms typical

ELECTRICAL CHARACTERISTICS OF BOARD WITH 6 ANALOG OUTPUTS + 1 bypass OUTPUT	
Analog Outputs	
Contacts and connection	2 connection points per output spring-type plug-in connection
Outputs level	0 / 10 VDC - 10 / 0 / 10 VDC 3 / 6 / 9 VDC 6 / 12 / 18 VDC
Voltage output max. current	10 mA
Bypass output	
Contacts and connection	2 connection points per output spring-type plug-in connection
Max. interrupting capacity	4A max
Max. voltage	30VDC

ELECTRICAL CHARACTERISTICS OF BOARD WITH 12 LOGIC INPUTS + 2 ANALOG INPUTS	
Outputs 12 VDC	50 mA max
Logic Inputs	
Contacts and connection	1 connection points per input, 4 common contacts spring-type plug-in connection
Consumption of an active input	<10 mA
Voltage	0 to 30 VDC
Low level on input	< 2VDC
High level on input	> 3VDC
Analog inputs	
Contacts and connection	2 connection points Spring-type plug-in connection
Max. input level	10 VDC or 4-20mA

 = See maximum current carrying capacity on connection terminals in section [Technical characteristics / Transceiver Alto and Connection interface unit PYR ATEX](#).

11.3.3 Receiver ELIO ATEX: CONTROL BOARD



ELECTRICAL CHARACTERISTICS OF CONTROL BOARD		
Safety relay		
Contact type		2 relays with linked contacts
Contacts and connection		2 connection points per outputs Spring-type plug-in connection
Indication		
Radio status and quality		1 Green indicator light:
Power on		1 yellow indicator light:
fault and diagnostic		1 red indicator light:
Function Relay		
		12
Contacts and connection		2 connection points per output spring-type plug-in connection
Outputs		Indépendent relays - Category DC13 0.5A / 24 VDC, AC15 2A / 230VAC - Interrupting capacity, 2000VA max. - Max. current 8A - Min. current 10 mA (12VDC min) - Max. voltage 250 VAC
The fonctionnal relay must be protected against over current by adding a fuse 5A / 250 VAC/T. The fuse is not provided by JAY électronique		
Response time		- On startup: 0.5s max. - On command: 200ms typical

 = See maximum current carrying capacity on connection terminals in section [Technical characteristics / Transceiver Alto and Connection interface unit PYR ATEX](#).

11.3.4 Receiver ELIO ATEX: EXTENSION BOARD (option)

ELECTRICAL CHARACTERISTICS OF BOARD		
Logic inputs		
Contacts and connection		2 4 connection points spring-type plug-in connection
High level on input		> 3VDC
Low level on input		< 2VDC
Voltage		0 – 30 VDC max
Active input consumption		< 20mA
Galvanic insulation		> 2.5kV
Analog outputs		
Contacts and connection		1 2 connection point per output spring-type plug-in connection
Voltage		0 – 10VDC or 4-20mA
Max. output current		< 10mA
Analog input		
Contacts and connection		1 2 connection point spring-type plug-in connection
Voltage		0 – 10VDC or 4-20mA
Active voltage input consumption		< 10mA
Modbus RTU Slave		
Contacts and connection		1 RS 485 serial link 2 connection outputs spring-type plug-in connection
Protection (D+/D-)		ESD/EMI
Data rate		1200, 2400, 4800, 9600, 19200, 38400, 57600, 115200 bit/s
Parity		None / even (default) / odd
Slave addressing		1 to 247

11.4 Connection interface unit PYR ATEX

Connection interface unit PYR ATEX	
	
ATEX Characteristics	Areas of use : Zones 1, 2, 21 and 22 Mode de protection : Enhanced safety
	Marking : CE 0081  II 2 GD Ex e IIC T6 Gb Ex tb IIIC T85°C Db LCIE 14 ATEX 3011 X IECEx LCIE 14.0013 X
Housing material	Inox
Closing the housing	4 stainless steel screws
Tightness	IP66
Weight (equipped housing)	8,5 kg
Dimensions (without antenna and Cable glands)	230 x 330 x 148 mm
Operating temperature range	-20°C to + 60°C
Storage temperature range	-30°C to + 70°C
Cable lead-out	- 2 cable glands M32 passageway for shielded cables to Alto ATEX transceiver housing - 2 cable glands M32 passageway for shielded power supply cables / control - 3 cable glands M20 passageway for shielded F13power supply cables / control
Cable glands material	Brass with nickel plating
 Maximum allowable current on the terminals	2 possible cases : 1) at least 12 terminals crossed by a 4A current working simultaneously (for example, for the ATEX Transceiver unit: 2 active safety relays + 4 function relays simultaneously; for the connection interface unit: 12 terminals may be loaded simultaneously). 2) A maximum current of 1A without limitation of terminals connected and loaded.

12 Warranty

All our products are guaranteed two years as of date of product manufacture (indicated on product), excluding wear parts. For the battery, the warranty period is limited to 1 year. Repair, modification or replacement of a device during the warranty period may not have the effect of extending the warranty period.

Limits of warranty :

The warranty does not cover defects resulting from :

- Transport,
- False manoeuvre or non-observance of connection diagrams when setting the equipment into service,
- Insufficient supervision or servicing, utilization not complying with the specifications detailed in the technical manual and, as a general rule, storage, operation or environment conditions (atmospheric, chemical, electrical or other conditions).
- Conditions not specified on order of the equipment

The warranty shall not apply subsequent to any modifications or additions to the equipment performed by the customer without written approval by JAY Electronique.

The JAY Electronique responsibility during the warranty period is limited to material and construction defects. This warranty comprises repair in the JAY workshops or replacement, free of charge, of parts recognized to be defective following expert inspection by the Jay Technical Department.

The warranty shall not give rise to any compensation for damage claims

Any disputes relative to a supply or settlement thereof shall be ruled by the COURT OF COMMERCE OF GRENOBLE, solely competent, even in the event of an Appeal or a plurality of defendants.

13 FCC Rules & Regulations (Federal Communications Commission)

The OEM integrators are responsible for ensuring that the end-user has no manual instructions to remove or install module.

Caution:

- The user that changes or modifications not expressly approved by **JAY Electronique** responsible for compliance could void the user's authority to operate the equipment.
- Any changes or modifications to this equipment not expressly approved by **JAY Electronique** may cause, harmful interference and void the FCC authorization to operate this equipment

This equipment has been tested and found to comply with the limits for a Class A digital device, pursuant to Part 15 of the FCC Rules. These limits are designed to provide reasonable protection against harmful interference when the equipment is operated in a commercial environment. This equipment generates, uses, and can radiate radio frequency energy and, if not installed and used in accordance with the instruction manual, may cause harmful interference to radio communications. Operation of this equipment in a residential area is likely to cause harmful interference in which case the user will be required to correct the interference at his own expense.

This portable equipment with its antenna complies with FCC's radiation exposure limits set forth for an uncontrolled environment. To maintain compliance, follow the instructions below:

1. This transmitter must not be co-located or operating in conjunction with any other antenna or transmitter.
2. Avoid direct contact to the antenna or keep contact to a minimum while using this equipment.

Authorized antennas: see chapter « Antennas »

Antenna installation requirements: see chapter « Installing the Receiver »

Radio module:

Depending of model used, the product contain FCC ID: OQMSB or FCC ID: OQMS5

Warning:

This module is used exclusively by **JAY Electronique**. This product and the antennas must be professionally installed.

14 IC Regulations (Industry Canada)

The OEM integrators are responsible for ensuring that the end-user has no manual instructions to remove or install module.

This class (A) digital apparatus complies with Canadian ICES-003.

This portable equipment with its antenna complies with RSS102's radiation exposure limits set forth for an uncontrolled environment. To maintain compliance, follow the instructions below:

1. This transmitter must not be co-located or operating in conjunction with any other antenna or transmitter.
2. Avoid direct contact to the antenna or keep contact to a minimum while using this equipment.

This radio control (IC: 3393A-SB or IC: 3393A-S5 depending of product model) has been approved by Industry Canada to operate with the antenna types listed below with the maximum permissible gain and required antenna impedance for each antenna type indicated. Antenna types not included in this list, having a gain greater than the maximum gain indicated for that type, are strictly prohibited for use with this device.

Authorized antennas: see chapter « Antennas »

Antenna installation requirements: see chapter « Installing the Receiver »

This device complies with Industry Canada's licence-exempt RSSs.

Operation is subject to the following two conditions:

1. This device may not cause harmful interference; and
2. This device must accept any interference received, including interference that may cause undesired operation of the device.

Radio module:

Depending of model used, the product contain FCC ID: OQMSB or FCC ID: OQMS5

Warning:

This modular is used exclusively by **JAY Electronique**. This module and the antennas must be professionally installed.

15 TAIWAN NCC Regulations (National Communications Commission)

15.1 General

Only products in band 2.4GHz are authorized by TAIWAN NCC.

Radio module:

Depending of model used, the product contain FCC ID: OQMS5

Warning:

*This modular is used exclusively by **JAY Electronique**. This module and the antennas must be professionally installed.*

15.2 Regulations

Article 12

Without permission, any company, firm or user shall not alter the frequency, increase the power, or change the characteristics and functions of the original design of the certified lower power frequency electric machinery.

Article 14

The application of low power frequency electric machineries shall not affect the navigation safety nor interfere a legal communication, if an interference is found, the service will be suspended until improvement is made and the interference no longer exists.

15.3 Features

Frequency range	2.4 GHz to 2.48 GHz
Numbers of channels	64
Channel bandwith	1.25MHz
Modulation type	DSSS
Data rate	44.4 kb/s
Power level adjustable step	10
RF power (regulation)	< 10 mW
Antenna	Internal antenna for operator module and both external antenna outputs for transceiver module (antenna diversity)

16 Safety parameters

Tests according to the test principles were conducted. Detailed reports are held in the laboratories files.

Function tests, error simulation, a review of the source code and documents are performed.

List of standards : see the document « *Declaration of conformity* » of the product



16.1 Parameters calculated according to EN ISO 13849-1 and EN ISO 13849-2





Please make sure to define RZ and RSF3 as safety relay to use the safety function "dual-way" input, safety button or Joystick.

Product		Parameters	Results
Transmitter BETA 	Safety stop	MTTFD	100 years
		DCAVG	99%
		Category	4
		Performance level	PLe Hypothesis: dop:220J; hop:24h; tcycle: 2800
	"Dual way" input F1 to F6, N1, N2, A13	MTTFd	53.72 years
		DCAVG	71.35%
		Category	2
		Performance level	PLd Hypothesis: dop:220J; hop:24h; tcycle: 300

Product		Parameters	Results
Transmitter GAMA 	Safety stop	MTTFD	100 years
		DCAVG	99%
		Category	4
		Performance level	PLe Hypothesis: dop:220J; hop:24h; tcycle: 2800
	Function buttons F1 to F10	MTTFD	100 years
		DCAVG	94.72 %
		Category	2
		Performance level	PLd Hypothesis: dop:220J; hop:24h; tcycle:600
	"Dual way" input N1, N2	MTTFd	63.39 years
		DCAVG	71.77%
		Category	2
		Performance level	PLd Hypothesis: dop:220J; hop:24h; tcycle: 300

Product		Parameters	Results
Transmitter MOKA & PIKA  	Emergency stop	MTTFD	100 years
		DCAVG	99%
		Category	4
		Performance level	PLe Hypothesis: dop:220J; hop:24h; tcycle: 3600
	Joystick	MTTFD	100 years
		DCAVG	85%
		Category	2
		Performance level	PLd Hypothesis: dop:220J; hop:24h; tcycle: 300
	Joystick and "Dual way"	MTTFD	100 years
		DCAVG	81.76%
		Category	2
		Performance level	PLd Hypothesis: dop:220J; hop:24h; tcycle: 300
	Safety button / enable switch (A14)	MTTFD	91.7 years
		DCAVG	93 %
		Category	2
		Performance level	PLd Hypothesis: dop:220J; hop:24h; tcycle: 300
"Dual way" input F1 to F4, N1, N2, V1, V2, V3, C1_1, C1_2, A13	MTTFD	54.7 years	
	DCAVG	69 %	
	Category	2	
	Performance level	PLd Hypothesis: dop:220J; hop:24h; tcycle: 300	

Product		Parameters	Results
Receiver ALTO 	Emergency stop	MTTFd	100 years
		DCAVG	99%
		Category	4
		Performance level	PLe Hypothesis: dop:220J; hop:24h; tcycle: 3600
	"Safety button"	MTTFd	100 years
		DCAVG	94.72%
		Category	2
		Performance level	PLd Hypothesis: dop:220J; hop:24h; tcycle: 3600
	Life signal (value are for both, transmitter and receiver side)/ safety function stop	MTTFd	59.08 years
		DCAVG	67.69%
		Category	2
		Performance level	PLd Hypothesis: dop:220J; hop:24h; tcycle: 3600

Product		Parameters	Results
Receiver ELIO 	Emergency stop	MTTFd	65.95 years
		DCAVG	99%
		Category	4
		Performance level	PLe Hypothesis: dop:220J; hop:24h; tcycle: 3600

16.2 Parameters calculated according EN 61508-1-7 and EN 62061

Parameters of the safety outputs calculated in accordance with EN61508-6 with the following parameters:

Product		Parameters	Results
Transmitter BETA 	Emergency stop	PFH _D	$6,29 \cdot 10^{-8}$ 1/h
		SSF	99%
		HFT	1
		SIL	3 Hypothesis: dop:220J; hop:24h; tcycle: 2800
	"Dual way" input F1 to F6, N1, N2, A13	PFH _D	$5,57 \cdot 10^{-7}$ 1/h
		SSF	60%
		HFT	0
		SIL	2 Hypothesis: dop:220J; hop:24h; tcycle: 300

Product		Parameters	Results
Transmitter GAMA 	Emergency stop	PFH _D	$9,86 \cdot 10^{-8}$ 1/h
		SSF	99%
		HFT	1
		SIL	3 Hypothesis: dop:220J; hop:24h; tcycle: 2800
	Function buttons F1 to F10	PFH _D	$1,62 \cdot 10^{-8}$ 1/h
		SSF	99%
		HFT	0
		SIL	2 Hypothesis: dop:220J; hop:24h; tcycle:600
	"Dual way" input N1, N2	PFH _D	$1,47 \cdot 10^{-7}$ 1/h
		SSF	66.73%
		HFT	0
		SIL	2 Hypothesis: dop:220J; hop:24h; tcycle: 300

Product		Parameters	Results
Transmitter PIKA/MOKA 	Emergency stop	PFH _D	1.92*10 ⁻⁸ 1/h
		SFF	99 %
		HFT	1
		SIL	3 Hypothesis: dop:220J; hop:24h; tcycle: 2800
	Joystick	PFH _D	4.17*10 ⁻⁸ 1/h
		SFF	77.82%
		HFT	0
		SIL	2 Hypothesis: dop:220J; hop:24h; tcycle: 300
	Joystick and “Dual way”	PFH _D	1.43*10 ⁻⁷ 1/h
		SFF	77.82%
		HFT	0
		SIL	2 Hypothesis: dop:220J; hop:24h; tcycle: 300
	Safety button / enable switch (A14)	PFH _D	8.31*10 ⁻⁸ 1/h
		SFF	90%
		HFT	0
		SIL	2 Hypothesis: dop:220J; hop:24h; tcycle: 300
	“Dual way” input F1 to F4, N1, N2, V1, V2, V3, C1_1, C1_2, A13	PFH _D	4.03*10 ⁻⁷ 1/h
		SFF	60%
		HFT	0
		SIL	2 Hypothesis: dop:220J; hop:24h; tcycle: 300

			Results
Receiver ALTO 	Emergency stop	PFH _D	4,86*10 ⁻⁹ 1/h (Failure rate output relay with B _{10D} = 250000, h _{op} = 24h, d _{op} = 220 days, t _{cyclus} = 3600)
		SFF	99 %
		HFT	1
		SIL	3 Hypothesis: dop:220J; hop:24h; tcycle: 3600
	"Safety button"	PFH _D	1.33*10 ⁻⁷ 1/h
		SFF	92.61%
		HFT	0
	Life signal (value are for both, transmitter and receiver side)/ safety function stop	SIL	2 Hypothesis: dop:220J; hop:24h; tcycle: 3600
		PFH _D	2,6*10 ⁻⁷ 1/h
		SFF	67.69%
		HFT	0
		SIL	2 Hypothesis: dop:220J; hop:24h; tcycle: 3600

Product		Parameters	Results
Reveiver ELIO 	Emergency stop	PFH _D	3,67*10 ⁻⁸ 1/h
		SFF	99%
		HFT	1
		SIL	3 Hypothesis: dop:220J; hop:24h; tcycle: 3600

16.3 « Stop times » characteristics

A radio control system is considered as a machine control device and as a safety component used to stop a machine as specified by the EEC Machinery Directive. All applicable rules must therefore be observed to ensure safe, correct operation of such devices. Before the integration of the system, they do need to perform a hazard and risk analysis according to 2006/42/EC, to decide if the safety function and reaction time are sufficient for the application, and to decide the correct passive stopping time. This parameter is configurable by **iDialog** software.

Note1: Please make sur that i **iDialog** is install on a computer protected against virus and with an updated protection.

- **Active stop time:** The time stop active is between 174 to 894ms. The extreme value (894ms) corresponding when only the tenth radio frame from transmitter is received correctly.
- **Passive stop time:** The passive stop time is configurable between 300ms to 2s. The real value of passive time is equal to: Passive time parameter value + 110ms maximum.
Note: In the case of using special functions with two Receivers controlled by one transmitter, it is possible to configure different passive stopping times on each Receiver.
Note: The passive stop time can be set by iDialog.
- **Safety Relay function (RZ on ALTO):**
The time to release the safety relay function after release of the associated function button is equal to 378 ms without disturbance radio message.
If the radio message is disturbed, in this case the time of release the safety relay function is equal to the delay of passive time stop.
- **Safety function input:**
In case of failure of a safety input, the safety function relay will be opened in 601ms + passive stop max.

17 Environmental characteristics

According to IEC 62368-1:2014 + AC:2015

NOTICE : This product has been designed for environment A. Use of this product may cause unwanted electromagnetic disturbances in which case the user may be required to take adequate mitigation measures.

Altitude of the site of installation does not exceed 2000 m.

The relative humidity of the air does not exceed 50 % at a maximum temperature of +40°C. Higher relative humidities may be permitted at lower temperatures, e.g. 90 % at + 20°C.

18 Residual risks

The product being an element of the equipment, a risk analysis of the concerned application will allow to estimate these residual risks.

19 Forseeable misuse

Polarity inversions of the Transceiver power supply : no starting up of products.

Other misuse of the radio remote control system : see chapter « Transceiver indicator light functions and messages ».

20 Product references

See product sales documentation.

21 Waste recycling and management



When the unit has reached the end of its service life, be sure to dispose of it appropriately. The unit can be disposed of in a specific waste collection centre as organised by the local authorities, or it can be turned over to a distributor who will handle proper disposal of the unit.

Electronic waste sorting will prevent possible negative impact on the environment resulting from inappropriate elimination of electronic waste and will allow proper processing and recycling of the materials forming the unit, representing significant savings in terms of energy and resources.

22 Manufacturer information



Manufacturer and plant:

JAY électronique

ZAC la Bâtie, rue Champrond
F38334 SAINT ISMIER cedex

Tel: +33 (0)4 76 41 44 00

www.jay-electronique.com

NOTES :



JAY électronique
ZAC la Bâtie, rue Champrond
F38334 SAINT ISMIER cedex

Tel: +33 (0)4 76 41 44 00

www.jay-electronique.com